

User Manual

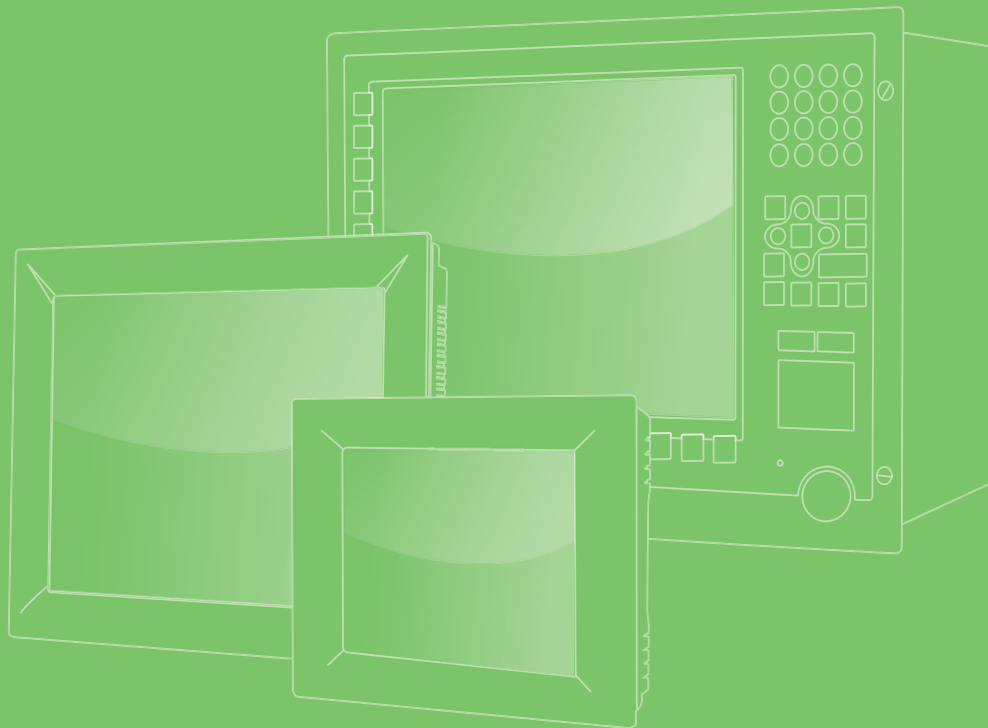

PPC-6151C/6171C/ 6191C

**15"/17"/19" Configurable Panel
PC Chassis with Selectable Mini-
ITX Motherboard**

ADVANTECH

Enabling an Intelligent Planet

Copyright

The documentation and software included with this product are copyrighted 2021 by Advantech Co., Ltd. All rights are reserved. Advantech Co., Ltd. reserves the right to improve the products described in this manual at any time without notice. No part of this manual may be reproduced, copied, translated, or transmitted in any form or by any means without the prior written permission of Advantech Co., Ltd. The information provided in this manual is intended to be accurate and reliable. However, Advantech Co., Ltd. assumes no responsibility for its use, nor for any infringements of the rights of third parties that may result from its use.

Acknowledgments

Intel® and Pentium® are trademarks of Intel® Corporation.

Microsoft Windows is registered trademark of Microsoft Corp.

All other product names or trademarks are properties of their respective owners.

Product Warranty (2 years)

Advantech warrants the original purchaser that each of its products will be free from defects in materials and workmanship for two years from the date of purchase.

This warranty does not apply to any products that have been repaired or altered by persons other than repair personnel authorized by Advantech, or products that have been subject to misuse, abuse, accident, or improper installation. Advantech assumes no liability under the terms of this warranty as a consequence of such events.

Because of Advantech's high quality-control standards and rigorous testing, most customers never need to use our repair service. If an Advantech product is defective, it will be repaired or replaced at no charge during the warranty period. For out-of-warranty repairs, customers will be billed according to the cost of replacement materials, service time, and freight. Please consult your dealer for more details.

If you think you have a defective product, follow the steps outline below:

1. Collect all the information about the problem encountered (for example, CPU speed, Advantech products used, other hardware and software used, etc.). Note anything abnormal and list any onscreen messages received when the problem occurs.
2. Call your dealer and describe the problem. Please have your manual, product, and any relevant information readily available.
3. If your product is diagnosed as defective, obtain an return merchandise authorization (RMA) number from your dealer. This allows us to process your return more quickly.
4. Carefully pack the defective product, a completed Repair and Replacement Order Card, and a proof of purchase date (such as a photocopy of your sales receipt) into a shippable container. Products returned without a proof of purchase date are not eligible for warranty service.
5. Write the RMA number visibly on the outside of the package, then ship the package prepaid to your dealer.

Declaration of Conformity

CE

This product has passed the CE test for environmental specifications. Test conditions for passing included the equipment being operated within an industrial enclosure. To protect the product from damage due to electrostatic discharge (ESD) or EMI leakage, we strongly recommend the use of CE-compliant industrial enclosure products.

FCC Class A

This equipment has been tested and found to comply with the limits for a Class A digital device, pursuant to part 15 of the FCC Rules. These limits are designed to provide reasonable protection against harmful interference when the equipment is operated in a commercial environment. This equipment generates, uses, and can radiate radio frequency energy and, if not installed and used in accordance with the instruction manual, may cause harmful interference to radio communications. Operation of this equipment in a residential area is likely to cause harmful interference, in which case users are required to correct the interference at their own expense.

Technical Support and Assistance

1. Visit the Advantech website at <http://support.advantech.com> to obtain the latest product information.
2. Contact your distributor, sales representative, or Advantech's customer service center for technical support if you need additional assistance. Please have the following information to hand before calling:
 - Product name and serial number
 - Description of your peripheral attachments
 - Description of your software (operating system, version, application software, etc.)
 - Comprehensive description of the problem
 - The exact wording of any error messages

Safety Instructions

1. Read these safety instructions carefully.
Veillez lire attentivement ce manuel d'instructions de sécurité.
2. Keep this startup manual for future reference.
Veillez conserver ce manuel d'instructions pour référence ultérieure.
3. Disconnect the equipment from all power outlets before cleaning. Use only a damp cloth for cleaning. Do not use liquid or spray detergents.
Débranchez l'appareil de toutes les prises de courant avant le nettoyage. Nettoyez-le uniquement à l'aide d'un chiffon humide. Ne pas utiliser de détergents liquides ou pulvérisateurs.
4. For pluggable equipment, the power outlet socket must be located near the equipment and easily accessible. Ensure to connect the power cord to a socket-outlet with earthing connection.
Pour les appareils enfichables, la prise de courant doit être placée près de l'appareil et facilement accessible. Veillez à cordon d'alimentation connecté à un socle de prises de courant avec connexion à la terre.
5. Protect the equipment from humidity.
Protégez l'appareil contre l'humidité.
6. Place the equipment on a reliable surface during installation. Dropping or letting the equipment fall may cause damage.
Placez l'appareil sur une surface fiable pendant l'installation. L'abandon ou la chute de l'appareil pourrait causer des dommages.
7. The openings on the enclosure are for air convection. Protect the equipment from overheating. Do not cover the openings.
Les ouvertures du boîtier sont pour la convection d'air. Protégez l'appareil contre la surchauffe. Ne couvrez pas les ouvertures.
8. Ensure that the voltage of the power source is correct before connecting the equipment to a power outlet. The power outlet socket should have grounded connection.
Assurez-vous que la tension de la source d'alimentation est correcte avant de connecter l'appareil à une prise de courant. La prise de courant doit avoir une bonne connexion mise à la terre.
9. Position the power cord away from high-traffic areas. Do not place anything over the power cord.
Placez le cordon d'alimentation à l'écart des zones à fort trafic. Ne placez rien sur le cordon d'alimentation.
10. All cautions and warnings on the equipment should be noted.
Attention à toutes les précautions et avertissements indiqués sur l'appareil.
11. If the equipment is not used for a long time, disconnect it from the power source to avoid damage from transient over-voltage.
Si l'appareil n'est pas utilisé pendant une longue période, déconnectez-le de la source d'alimentation pour éviter les dommages causés par une surtension transitoire.
12. Never pour liquid into an opening. This may cause fire or electrical shock.
Ne versez jamais de liquide dans une ouverture. Sinon, cela pourrait provoquer un incendie ou un choc électrique.
13. Never open the equipment. For safety reasons, the equipment should be opened only by qualified skilled person.
N'ouvrez jamais l'appareil. Pour des raisons de sécurité, l'appareil ne doit être ouvert que par un technicien qualifié.
14. If one of the following occurs, have the equipment checked by service personnel:
Si l'un des cas suivants se produit, demandez aide à un technicien qualifié:

- The power cord or plug is damaged.
Le cordon d'alimentation ou la fiche est endommagé.
 - Liquid has penetrated the equipment.
Le liquide a pénétré dans l'appareil.
 - The equipment has been exposed to moisture.
L'appareil a été exposé à l'humidité.
 - The equipment is malfunctioning or does not function according to the user manual.
L'appareil est défectueux ou ne fonctionne pas conformément aux instructions.
 - The equipment has been dropped and damaged.
L'appareil a été aba donné et endommagé.
 - The equipment shows obvious signs of breakage.
L'appareil montre des signes évidents de rupture.
15. Do not leave the equipment in an environment with a storage temperature of below -20 °C (-4 °F) or above 60 °C (140 °F) as this may cause damage. The equipment should be kept in a controlled environment.
Ne laissez pas cet appareil dans un environnement dont la température de stockage est inférieure à -20 °C (-4 °F) ou supérieure à 60 °C (140 °F), car cela pourrait causer des dommages. L'appareil doit être surveillé dans l'environnement.
16. CAUTION: Batteries are at risk of exploding if incorrectly replaced. Replace only with the same or equivalent type as recommended by the manufacturer. Discard used batteries according to the manufacturer's instructions.
ATTENTION: Il y a danger d'explosion s'il y a remplacement incorrect de la pile. Remplacer uniquement avec une pile du même type ou d'un type équivalent recommandé par le constructeur.
17. In accordance with the IEC 704-1:1982 specifications, the sound pressure level at the operator's position does not exceed 70 dB (A).
Conformément aux spécifications de l'IEC 704-1:1982, le niveau de pression acoustique à la position de l'opérateur ne dépasse pas 70 dB (A).
18. DISCLAIMER: These instructions are provided in accordance with IEC 704-1 standards. Advantech disclaims all responsibility for the accuracy of any statements contained herein.
AVERTISSEMENT: ces instructions sont fournies conformément aux normes IEC 704-1. Advantech décline toute responsabilité quant à la précision de toute déclaration contenue dans le présent document.
19. Warning message for using product in ITE environment
Suitable for installation in Information Technology Rooms in accordance with Article 645 of the National Electrical Code and NFPA 75.
Peut être installé dans des salles de matériel de traitement de l'information conformément à l'article 645 du National Electrical Code et à la NFPA 75.

Safety Precautions - Static Electricity

Follow these simple precautions to protect yourself from harm and the products from damage:

- To avoid electrical shock, always disconnect the power from the PC chassis before manual handling. Do not touch any components on the CPU card or other cards while the PC is switched on.
- Disconnect all power before making any configuration changes. A sudden rush of power when connecting a jumper or installing a card may damage sensitive electronic components.

Power Warning

The power is suitable for areas with an altitude below 5000 m (16,404 ft)





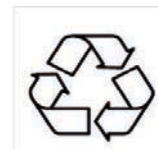

Battery Information





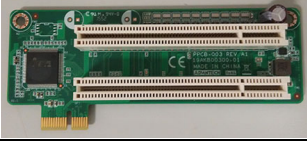







Batteries, battery packs, and accumulators should not be disposed of in unsorted household waste. Please use the public collection system to return, recycle, or treat them in compliance with your local regulations.



Initial Inspection

Upon opening the shipping carton, check that the items below are included in the shipment.

Model	Item	Qty	Image
PPC-6151C/6171C/ 6191C-RTAE	Chassis	1	
	Riser card PCIe x4	1	
	Riser card PCI	1	
	User manual	1	
	Warranty card	1	
	HDD screws	4	
	M/B and riser card screws	6	
	Panel bracket and screws	10/12	
	Mini PCIe screw	1	

Model	Item	Qty	Image
PPC-6151C/6171C/ 6191C-RMAE	Chassis	1	
	Riser card PCIe x4	1	
	Riser card PCI	1	
	DP input cable	1	
	USB input cable	1	
	SATA cable	1	
	SATA power cable	1	
	User manual	1	
	Warranty card	1	
	HDD screws	8	
	M/B and riser card screw	6	
	Panel bracket and screws	10/12	
	DC bracket	1	
	DC bracket screws	2	
	Mini PCIe screw	1	

If any of the aforementioned items are missing or damaged, contact your distributor or sales representative immediately. We have carefully inspected the product mechanically and electrically before shipment. The product should be free of marks and scratches and in perfect working order upon receipt. As you unpack the product, check the equipment for signs of shipping damage (for example, damaged box, scratches, dents, etc.). If the product is damaged or fails to meet the specifications, notify our service department or your local sales representative immediately. Additionally, please notify the carrier. Retain the shipping carton and packing material for inspection by the carrier. After inspection, we will make arrangements to repair or replace the unit.

Contents

Chapter 1 Introduction.....1

1.1	Overview	2
1.2	Chassis Comparison	3
1.3	Specifications	4
1.3.1	Specifications Comparison	4
1.3.2	General Specifications	4
1.4	External View	5
1.5	Dimensions	7
	Figure 1.1 PPC-6151C Dimensions.....	7
	Figure 1.2 PPC-6171C Dimensions.....	8
	Figure 1.3 PPC-6191C Dimensions.....	9

Chapter 2 System Installation and Setup11

2.1	Anti-Static Precautions.....	12
2.2	PPC-6151C/6171C/6191C-RTAE Motherboard Installation	12
2.2.1	Remove the Back Cover	12
2.2.2	Remove the Reinforced Board.....	13
2.2.3	Install the PPC-MB-8260AE Motherboard	13
2.2.4	Connect the Motherboard Wires	16
2.2.5	Install the PPC-MB-610 Motherboard	17
2.2.6	Connect the Motherboard Wires	21
2.3	PPC-6151C/6171C/6191C-RMAE Motherboard Installation.....	23
2.3.1	Install the Mini-ITX Motherboard (AIMB-275)	23
2.3.2	Connect the Motherboard Wires	27
2.3.3	Connect the Daughter Board and Motherboard Using a Cable ..	30
2.4	Component Setup	32
2.4.1	CPU Installation	32
2.4.2	CPU Cooler Installation.....	32
2.4.3	Memory Installation.....	33
2.4.4	HDD Installation.....	34
2.4.5	Wi-Fi Module Installation.....	37
2.4.6	Expansion Card Installation	39
2.4.7	Graphic card Installation (Only for PPC-MB-610).....	40
2.4.8	TPM Module Installation (only for PPC-MB-610).....	43
2.4.9	Rear Cover Installation	44
2.5	Mounting the System	45
2.5.1	Wall Mounting	45
	Figure 2.1 Wall Mount Plate	46
	Figure 2.2 Screw Locations on the Rear Panel	46
	Figure 2.3 Mounting the Panel PC on a Wall.....	47
	Figure 2.4 Securing the Panel PC	47
2.5.2	Arm Mounting.....	48
	Figure 2.5 Arm Mounts for Panel PCs	48
2.5.3	Stand Mounting.....	49
	Figure 2.6 VESA Mount Screw Holes	49
	Figure 2.7 Securing the VESA Mount Base.....	50
	Figure 2.8 Securing the VESA Mount Bracket.....	50
	Figure 2.9 Securing the Stand Mount Hinge Cover	51
	Figure 2.10Completed Stand Mount.....	51
2.5.4	Panel Mounting	52
2.6	Quick Installation.....	53

Appendix A PCI/PCIE Riser Card 55

A.1	Riser Card Introduction	56
A.1.1	PPCB-003 PCI Riser Card.....	56
A.1.2	PPCB-006 PCIE x4 Riser Card	56
A.1.3	EAMB-BE02 2x PCIe x 1 Riser Card.....	57
A.1.4	EAMB-BE03 1 x PCIe x 1+1 x PCI Riser Card.....	57
A.1.5	EAMB-BE17 2 x PCIe x 8 Riser Card (for PPC-MB-610(U) only) ..	58
A.1.6	EAMB-BE20 PCIe x 16 Riser Card(for PPC-MB-610(U) only) ...	58

Chapter 1

Introduction

- Overview
- Features
- Chassis Comparison
- Specifications
- External View
- System View
- Dimensions

1.1 Overview

The PPC-6151C/6171C/6191C is a panel PC chassis developed for Mini-ITX motherboards. These chassis are equipped with a 15"/17"/19" TFT LED panel. PPC-6151C/6171C/6191C supports a selection of Mini-ITX motherboards to satisfy diverse customer requirements regarding price and functionality.

PPC-6151C/6171C/6191C also features a true flat bezel to meet market demands for a stylish design, as well as an additional reservation port and expansion slot to accommodate various applications. The PPC-6151C/6171C/6191C series devices were developed using two design concepts — optimization and compatibility.

Features:

- 15"/17"/19" true-flat PPC with resistive touch
- Supports certified Mini-ITX motherboards, up to 65 W TDP processor
- Supports two PCI/PCIe expansion slots
- Front-facing LED indicators for power status
- Front panel is IP65 compliant
- Optional VESA mount available upon request

1.2 Chassis Comparison

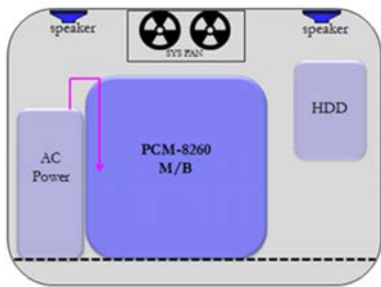
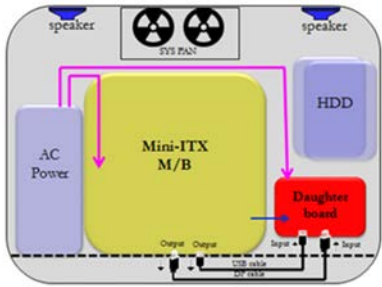
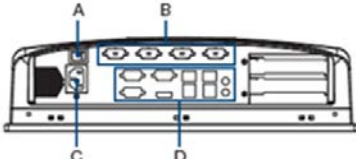
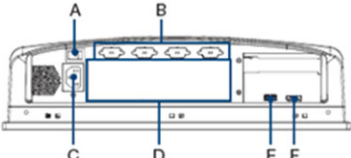
Chassis P/N	PPC-6151C/6171C/6191C-RTAE	PPC-6151C/6171C/6191C-RMAE
Design Goal	Highly optimized	Highly compatible
Supported Motherboard Type	Must follow design guide	Compatible with most Mini-ITX motherboards certified by Advantech
Daughter Board	Unnecessary	Necessary (additional cabling for external USB and DP)
Riser Card	2 slots	1 slot
HDD Kit	1	2
Speaker	2 x 1W	Optional
Advantage	1. Reduced cabling 2. Cost effective (w/o daughter board)	1. Compatible with most Mini-ITX motherboards
Internal Box Structure		
I/O View	 A. Power Switch B. Reservation port C. AC inlet D. PPC-MB-8260AE I/O port	 A. Power Switch B. Reservation port C. AC inlet D. Mini-ITX M/B I/O port E. USB2.0 (input, for connecting M/B and touch controller) F. Display port (input, for connecting M/B and touch controller)

Note!  Users can determine which chassis they are using by checking whether the system features a USB port and a DP port. After identifying the chassis type, refer to Chapters 2.3 and 2.4 (PPC-6151C/6171C/6191C-RTAE and PPC-6151C/6171C/6191C-RMAE, respectively) for installation.

Note!  When selecting a motherboard, please refer to the PPC-6151C/6171C/6191C selection guide.

1.3 Specifications

1.3.1 Specifications Comparison

Product	PPC-6151C-RTAE/RMAE	PPC-6171C-RTAE/RMAE	PPC-6191C-RTAE/RMAE
LCD	15" LCD	17" LCD	19" LCD
Display Type	15" TFT LCD (with LED backlight)	17" TFT LCD (with LED backlight)	19" TFT LCD (with LED backlight)
Max. Resolution	1024 x 768	1280 x 1024	1280 x 1024
Dot Matrix	0.297 x 0.297 mm	0.264 x 0.264 mm	0.294 x 0.294 mm
Viewing Angle	88 (left), 88 (right) 88 (top), 88 (bottom)	80 (left), 80 (right) 60 (top), 80 (bottom)	85 (left), 85 (right) 80 (top), 80 (bottom)
Brightness	500 cd/m ²	350 cd/m ²	350 cd/m ²
Contrast	2500	800	1000
Weight	5.03 kg (11.08 lb)	5.4 kg (11.9 lb)	5.8 kg (12.8 lb)
Dimensions	391.4 x 312.5 x 103.6 mm (15.4 x 12.3 x 4.08 in)	437 x 357 x 107.6 mm (17.2 x 14.06 x 4.2 in)	454 x 379.8 x 107.5 mm (17.9 x 15 x 4.2 in)

1.3.2 General Specifications

		PPC6151C/6171C/6191C-RTAE	PPC-6151C/6171C/6191C-RMAE
Chassis Features	Storage	1x 2.5" SATA bay	2x 2.5" SATA bay
	I/O	2x WLAN antenna ports	
		1x AC jack	4x Reserved connectors (DB9) 1x AC jack 1x Power switch 1x DP* 1x USB 2.0**
		1x Power switch	
		1x VGA	
		1x DP*	
1x DIO			
4x RS232	Reserved ports: According to motherboard specifications		
1x RS232/422/485			
2x LAN			
4x USB 3.0/6 x USB 3.0			
1x Line-Out			
1x Mic-In			
Expansion	Either 1 x PCIe x4 or 2 x PCI (in the accessory box)	Either 1x PCIe x4 or 1x PCI (in the accessory box)	
Speaker	2x 1W	2x 1W (optional)	
Fan	2x 12 V (60 x 60 x 15 mm/)		
OS Support	OS Support	Based on motherboard specifications	
Power Consumption	Input Voltage	100 ~ 240 VAC, 250 W	
LCD	Backlight Lifetime	50,000 hours minimum	
Touchscreen	Touch Type	Analog resistive 5-wire/projected capacitive (optional)	
	Light Transmission	80+/-5%	
	Controller	USB interface	
	Durability	35 million touches	

Environment	Operating Temperature	0 ~ 50 °C (32 ~ 122 °F)
	Storage Temperature	-30 ~ 60 °C (-22 ~ 140 °F)
	Relative Humidity	10 ~ 95% @ 40 °C (non-condensing)
	Shock	Operating 10 G peak acceleration (11 ms duration), follows IEC 60068-2-27
	Vibration	Operating random vibration test 5 ~ 500Hz, 1Grms @with HDD, follows IEC 60068-2-64
	EMC	CE, FCC Class A
	Front Panel Protection	IP65 compliant

Note! *1x DP (for connecting the motherboard and LVDS panel)



**1x USB 2.0 (for connecting the motherboard and touch controller)

1.4 External View

The front of PPC-6151C/6171C/6191C is a flat panel LCD screen enclosed in an aluminum frame. (When placed upright on a desk, the PPC-6151C/6171C/6191C front panel appears as shown below.)



PPC-6151C/6171C/6191C-RTAE Off (S3, S4, S5): orange; On (S0): blue
 PPC-6151C/6171C/6191C-RMAE Off (S3, S4, S5): orange or off; On (S0): blue

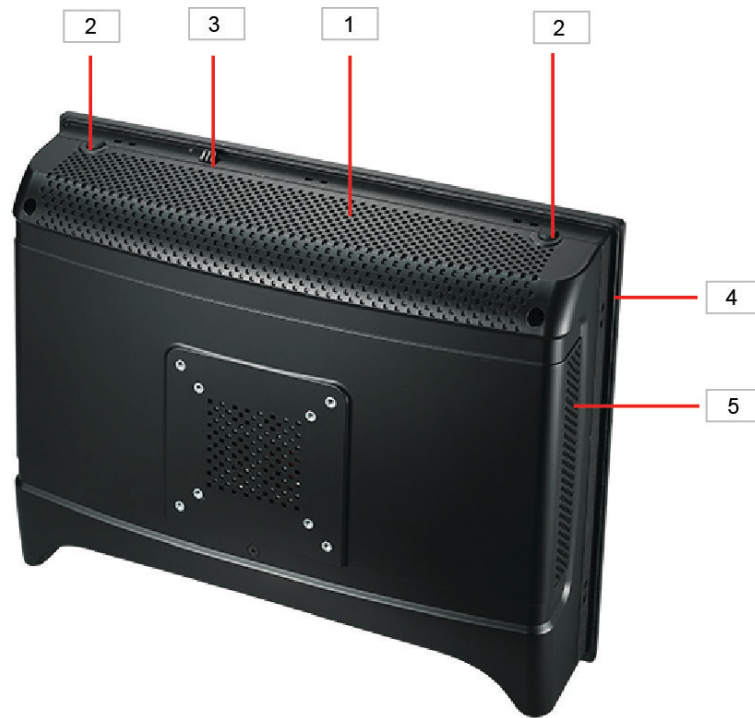

1. Air outlets
2. Antenna holes
3. Quick installation clip (1)
4. Panel mount bracket holes (10 for PPC-6151C/6171C and 12 for PPC-6191C)
5. Air inlets

1.5 Dimensions

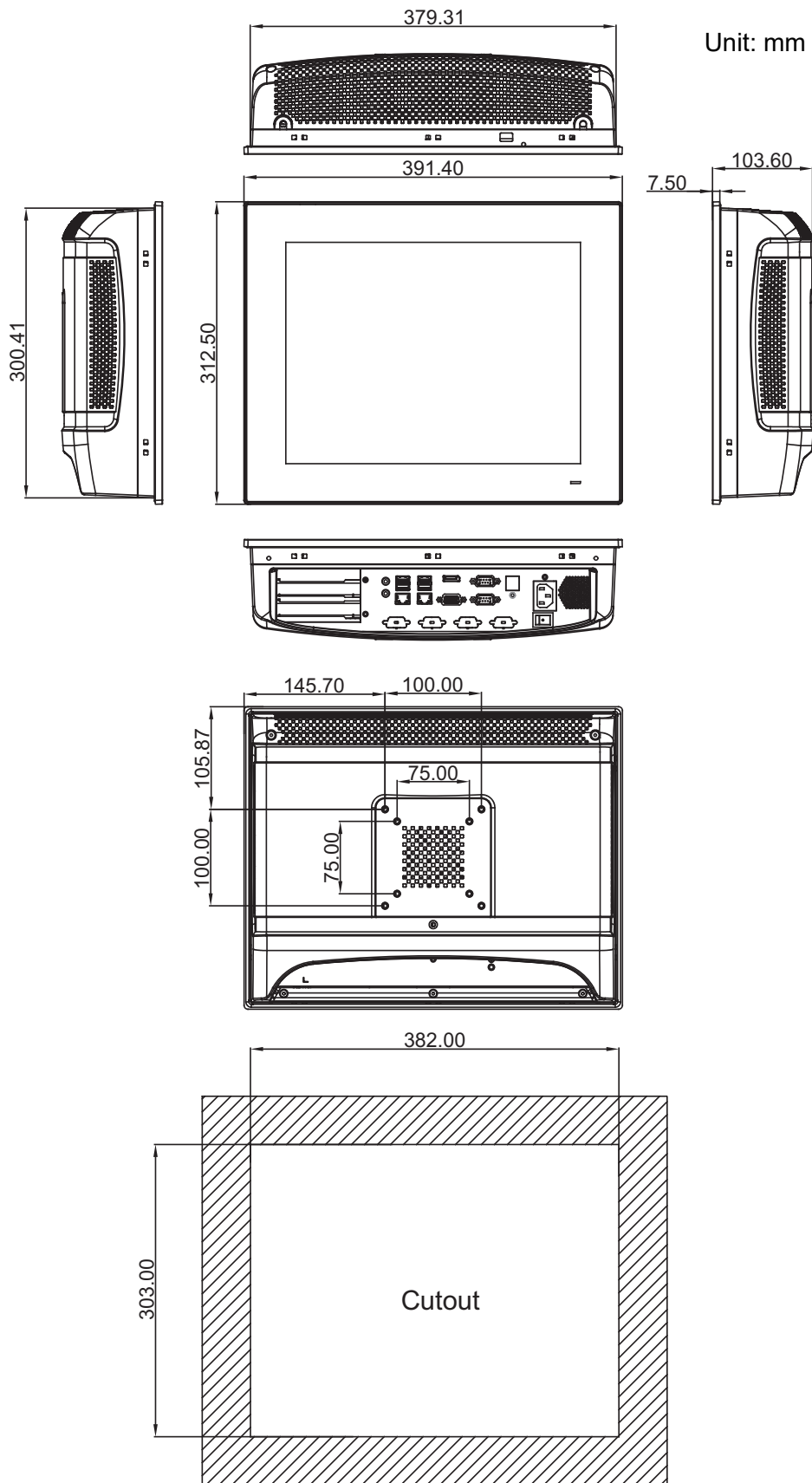

Figure 1.1 PPC-6151C Dimensions

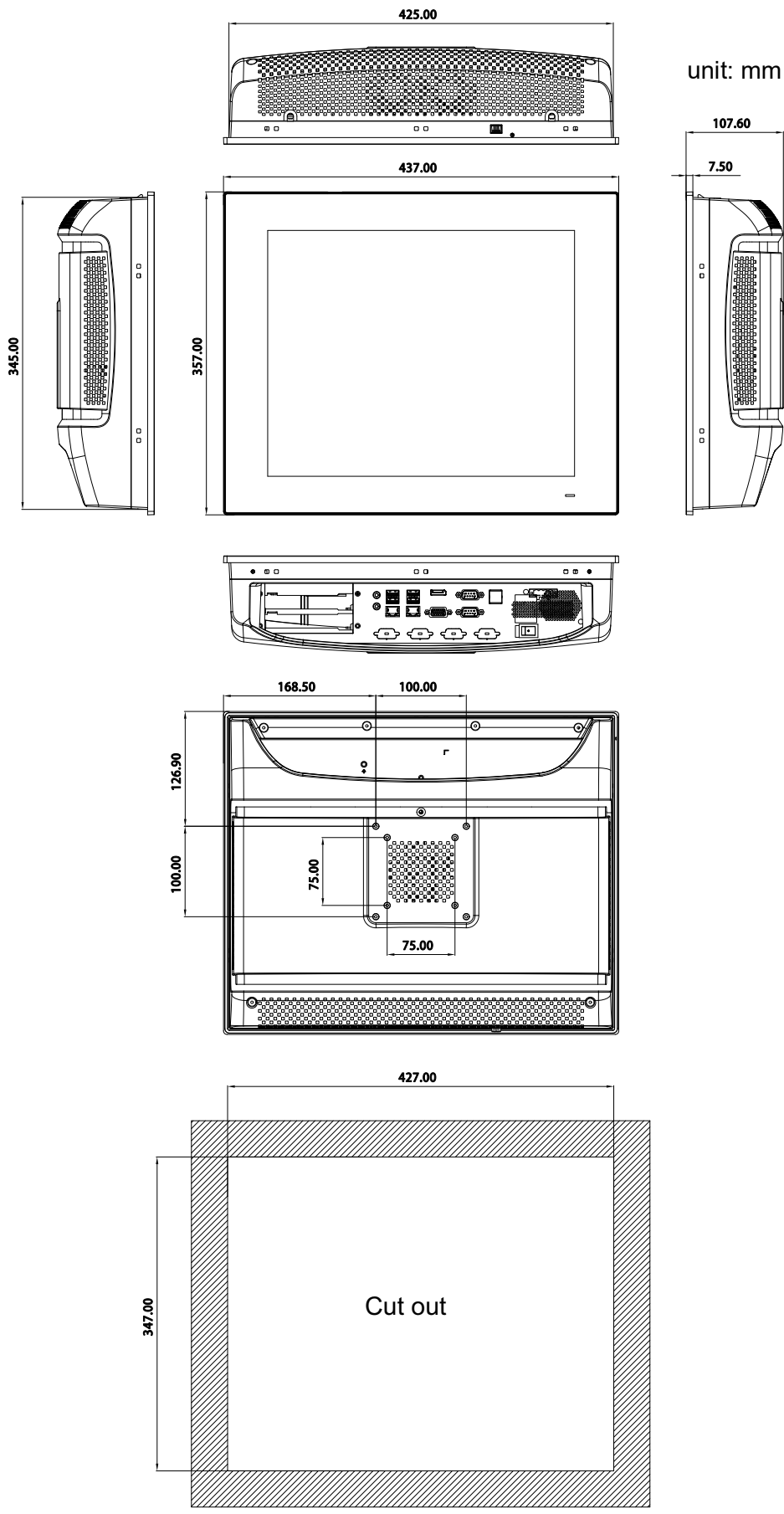

Figure 1.2 PPC-6171C Dimensions

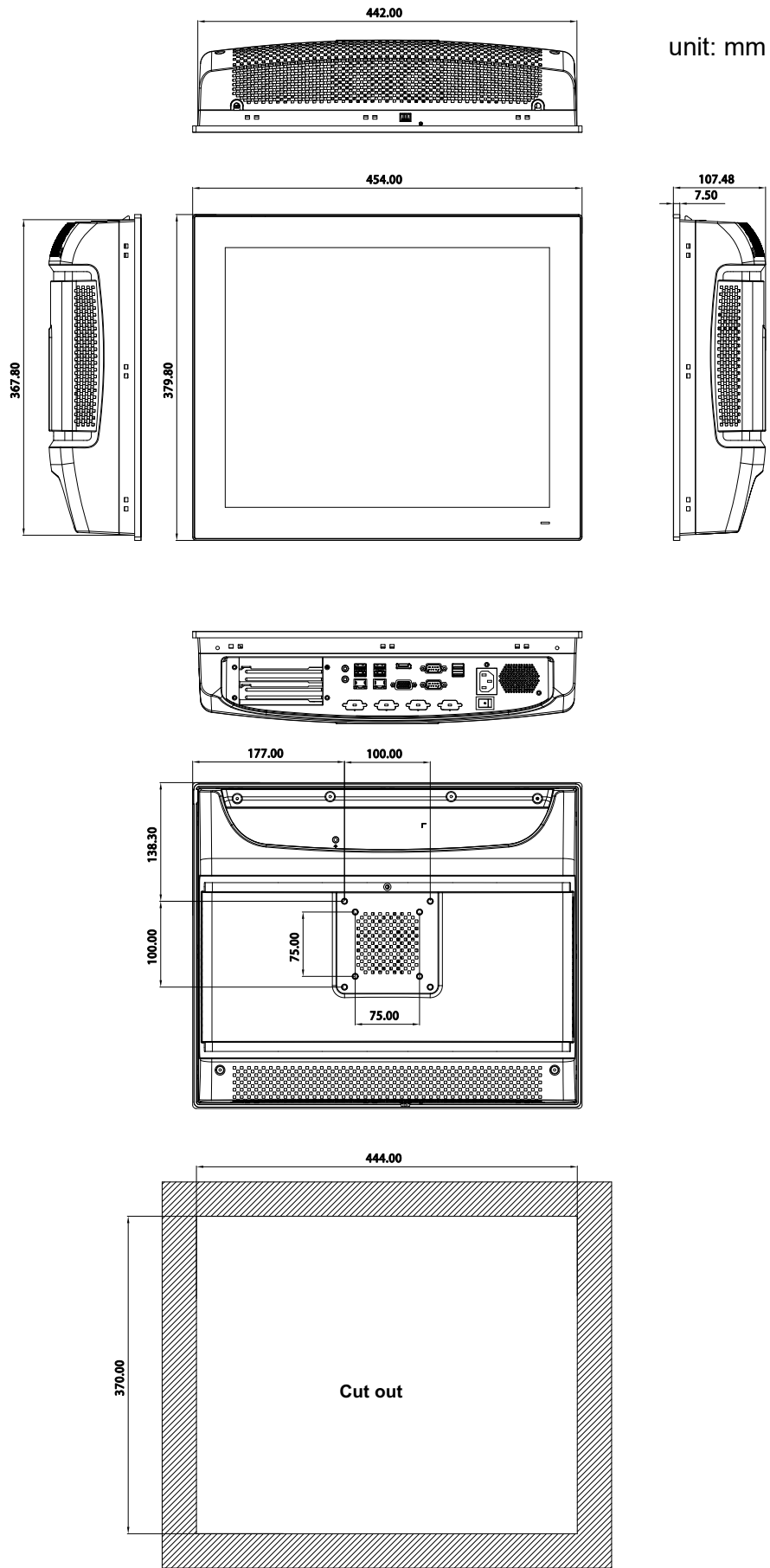

Figure 1.3 PPC-6191C Dimensions

Fixed VESA screw specification: M4; screw depth: 8 mm/0.31 in (Max)

Warning! Use suitable mounting apparatus to avoid risk of injury.



Chapter 2

System Installation and Setup

- Anti-Static Precautions
- Installation Procedures
- PPC-6151C/6171C/6191C-RTAE
Motherboard Installation
- PPC-6151C/6171C/6191C-RMAE
Motherboard Installation
- Component Setup
- Mount Installation
- Quick Installation

2.1 Anti-Static Precautions

Electrostatic discharge (ESD) can cause serious damage to electronic components, including the PPC model. ESD is especially common in dry climates. Therefore, when manually handling or accessing any of the PPC model's internal components, anti-static precautions should be strictly followed.

Always wear an anti-static wristband when handling the PPC model; this can prevent ESD from damaging the board or causing personal injury.

Note! Refer to Chapter 1.3 (Chassis Comparison) to determine the chassis type, then refer to Chapters 2.3 and 2.4 (for PPC-6151C/6171C/6191C-RTAE and PPC-6151C/6171C/6191C-RMAE, respectively) for the installation guidelines.



Warning! Failure to take appropriate ESD precautions during maintenance may result in permanent damage to the PPC and severe injury to the user.



2.2 PPC-6151C/6171C/6191C-RTAE Motherboard Installation

2.2.1 Remove the Back Cover

Unscrew the six screws and remove the rear cover.

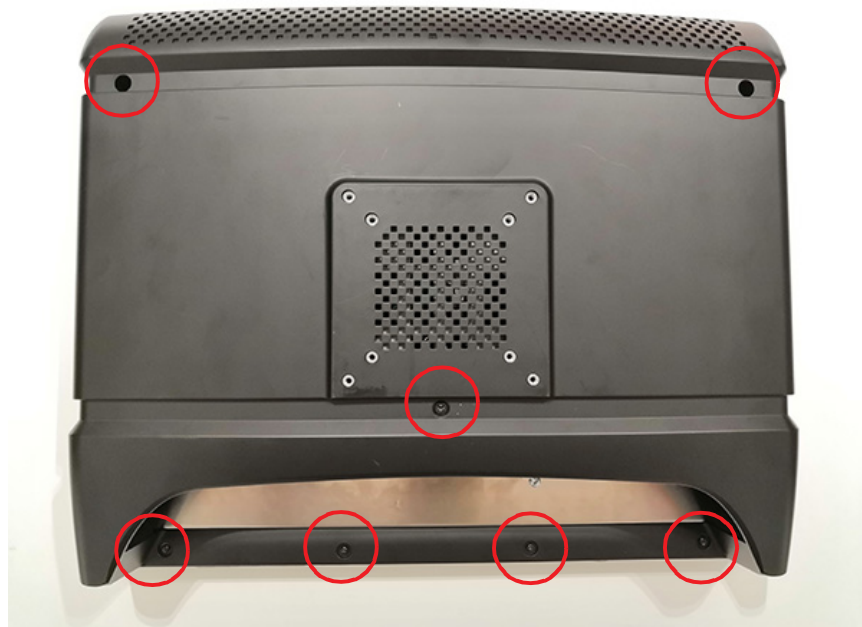

2.2.2 Remove the Reinforced Board

Remove the two screws on the reinforced board.

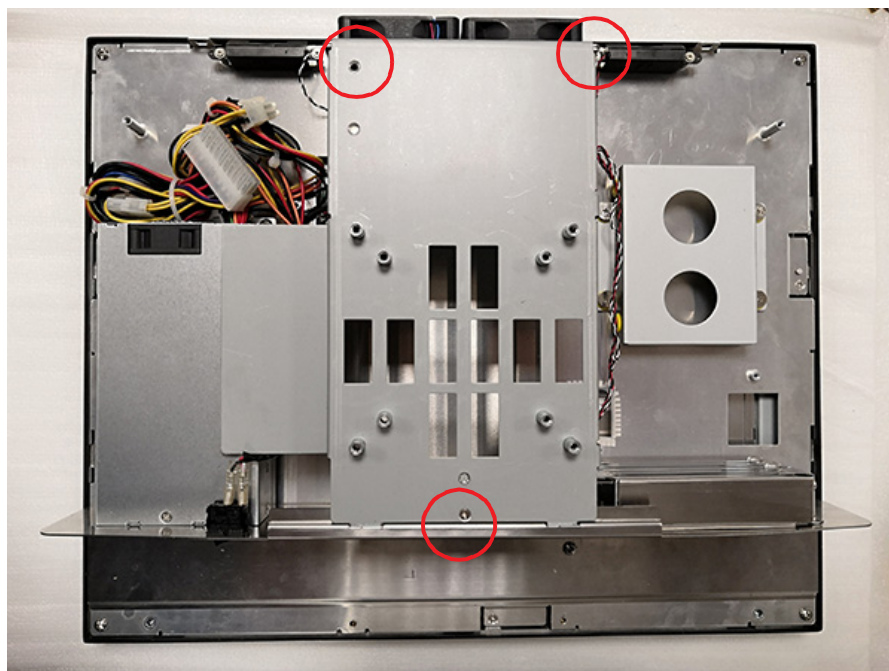

2.2.3 Install the PPC-MB-8260AE Motherboard

The image below shows the PPC-MB-8260AE motherboard with PPC-6151C-RTAE.

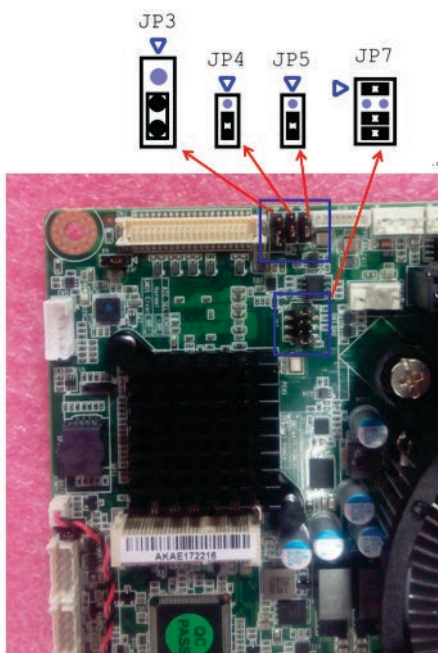

JP7	Resolution	1024 x 768 (24 bit)
JP3	LED panel PWR	+3.3 V
JP4	Backlight level	+3.3 V
JP5	Brightness PWM level	+3.3 V

The image below shows the PPC-MB-8260AE motherboard with PPC-6171C-RTAE.

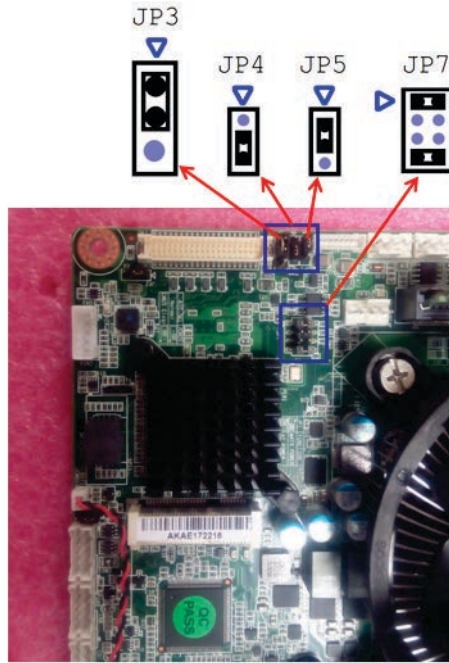

JP7	Resolution	1280 x 1024 (24 bit)
JP3	LED panel PWR	+5 V
JP4	Backlight level	+3.3 V
JP5	Brightness PWM level	+5 V

The image below shows the PPC-MB-8260AE motherboard with PPC-6191C-RTAE.

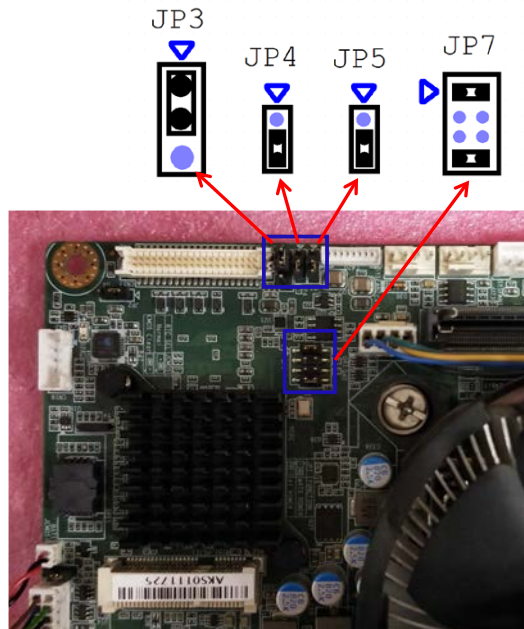

JP7	Resolution	1280 x 1024 (24 bit)
JP3	LED panel PWR	+5 V
JP4	Backlight level	+3.3 V
JP5	Brightness PWM level	+3.3 V

Note! For more information regarding the jumpers and connectors, please refer to the PPC-MB-8260AE startup manual (P/N:2003826000).



Using the four screws provided in the accessory box, affix the motherboard to the motherboard frame. (Motherboards must be purchased separately.) And connect the ATX cable.

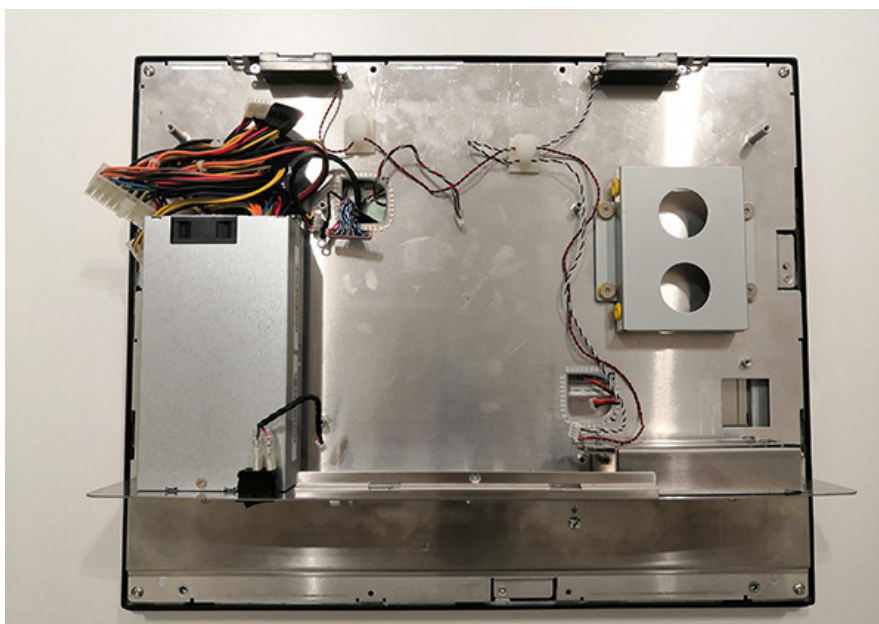
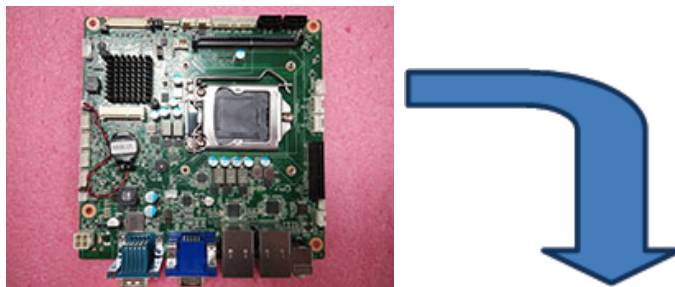

Note! Please refer to the datasheet when selecting the motherboard type in order to ensure optimum performance, maximum security, and sufficient air circulation.





2.2.4 Connect the Motherboard Wires

PPC-6151C/6171C/6191C-RTAE and PPC-MB-8260AE assembly.

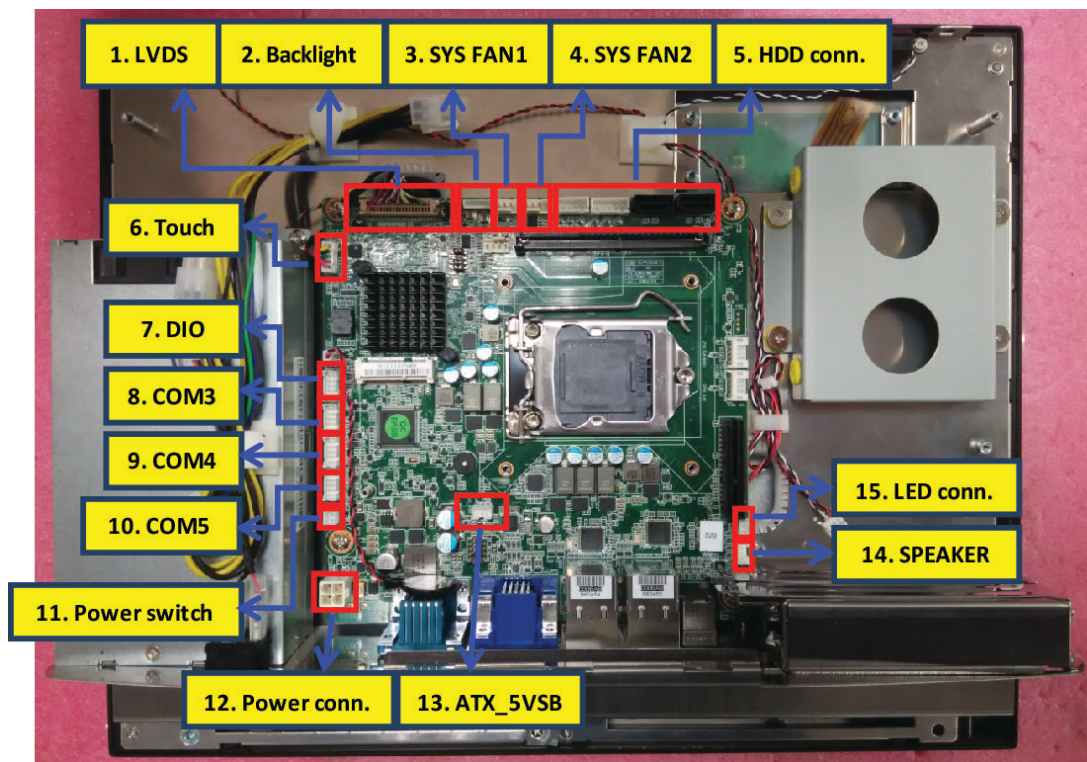

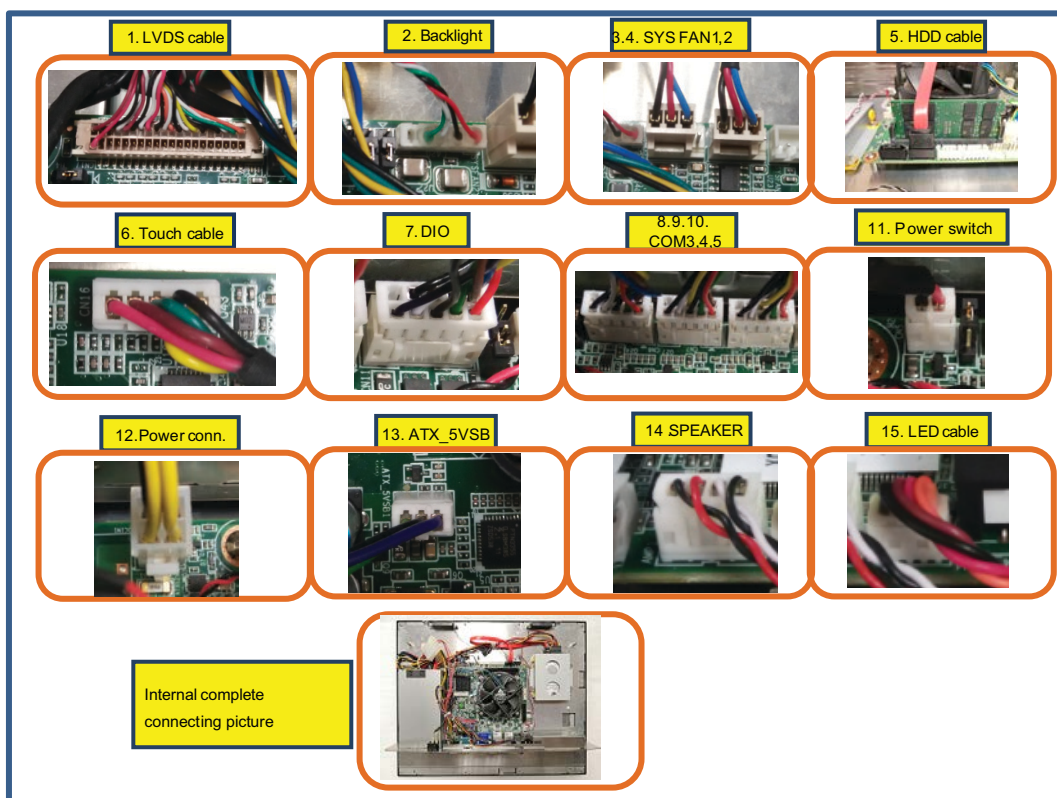

- Note!**
1. The COM cable and DIO cable are the same.
 2. The cable connection is based on the motherboard specifications.
 3. COM Cable and SATA Cable are in the motherboard accessory box.

2.2.5 Install the PPC-MB-610 Motherboard

The image below shows the PPC-MB-610 motherboard with PPC-6151C-RTAE.

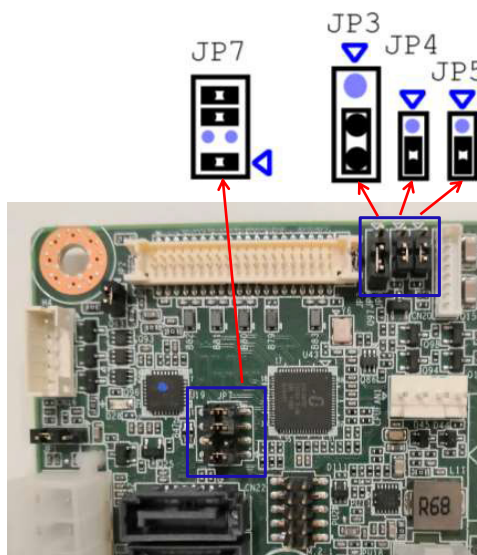

JP7	Resolution	1024*768(24bit)
JP3	LED panel PWR	+3.3V
JP4	Backlight level	+3.3V
JP5	Brightness PWM level	+3.3V

The image below shows the PPC-MB-610 motherboard with PPC-6171C-RTAE.

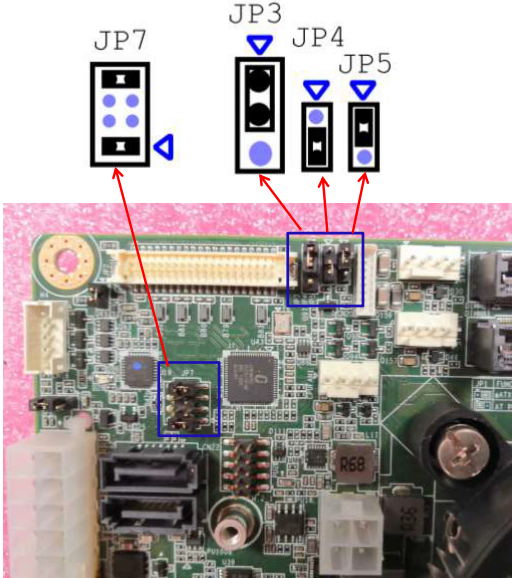

JP7	Resolution	1280*1024(24bit)
JP3	LED panel PWR	+5V
JP4	Backlight level	+3.3V
JP5	Brightness PWM level	+5V

The image below shows the PPC-MB-610 motherboard with PPC-6191C-RTAE.

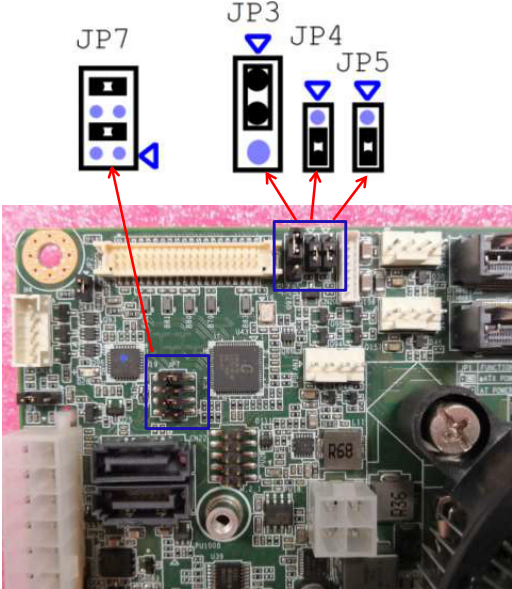

JP7	Resolution	1280*1024(24bit)
JP3	LED panel PWR	+5V
JP4	Backlight level	+3.3V
JP5	Brightness PWM level	+3.3V

1. Remove the USB baffle and using the four screws provided in the accessory box, secure the motherboard to the motherboard frame (motherboards must be purchased separately).



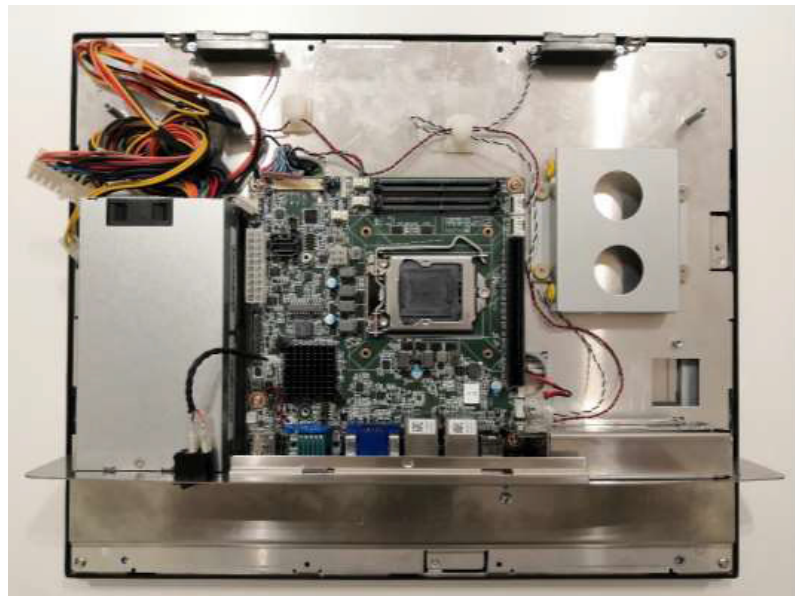
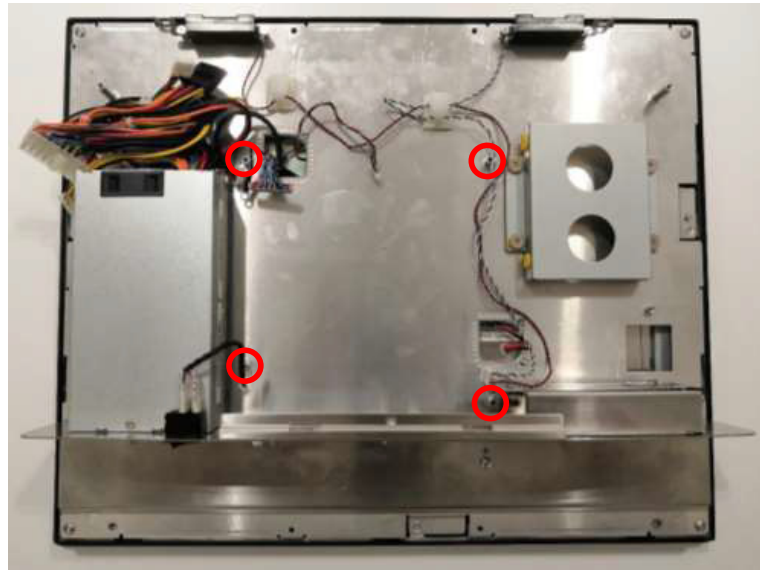

2.2.6 Connect the Motherboard Wires

PPC-6151C/6171C/6191C-RTAE and PPC-MB-610 assembly.

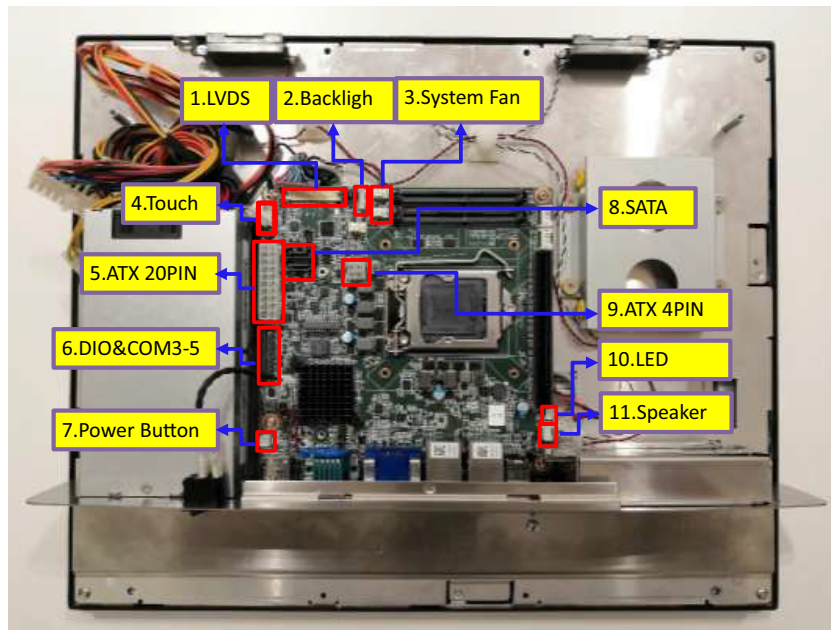

1.LVDS



2.Backligh



3.System Fan



4.Touch



5.ATX 20PIN



6.DIO&COM3-5



7.Power Button



8.SATA



9.ATX 4PIN



10.LED



11.Speaker

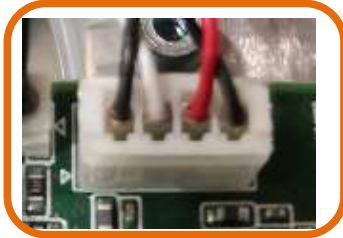

Internal complete connecting picture



2.3 PPC-6151C/6171C/6191C-RMAE Motherboard Installation

2.3.1 Install the Mini-ITX Motherboard (AIMB-275)

The image below shows the AIMB-275 motherboard with PPC-6151C-RMAE.

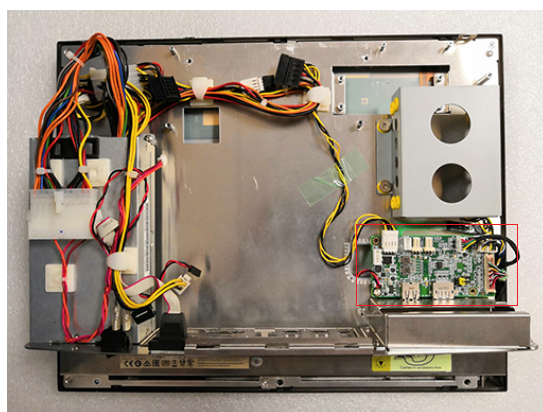
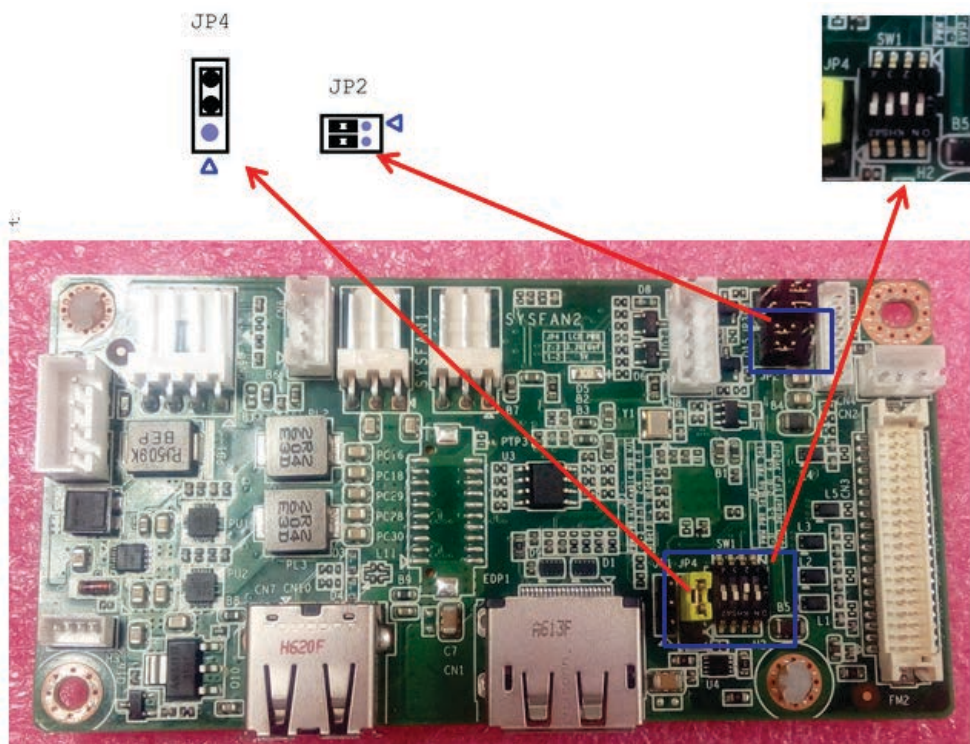

SW1	Resolution	1024 x 768 (24 bit)
JP4	LED panel PWR	+3.3 V
JP2(4-6)	Backlight level	+3.3 V
JP2(3-5)	Brightness PWM level	+3.3 V

The image below shows the AIMB-275 motherboard with PPC-6171C-RMAE.

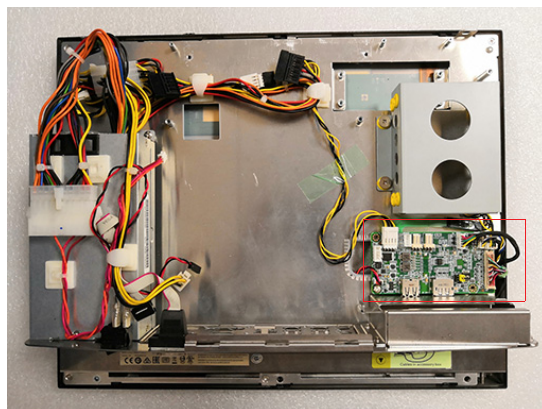
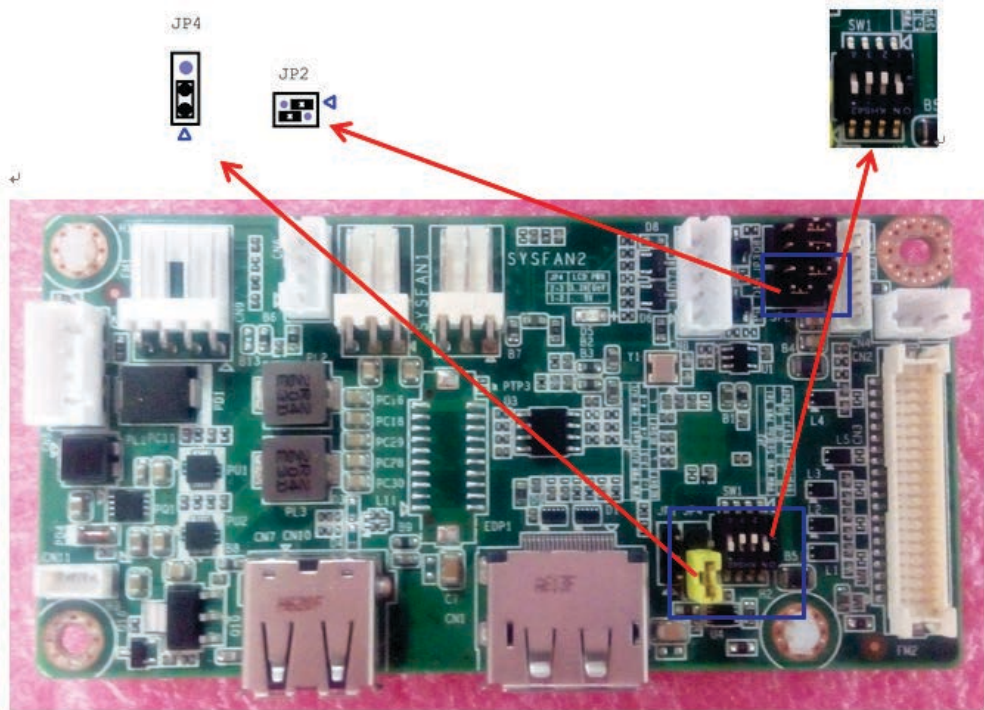

SW1	Resolution	1280 x 1024 (24 bit)
JP4	LED panel PWR	+5 V
JP2(4-6)	Backlight level	+3.3 V
JP2(1-3)	Brightness PWM level	+5 V

The image below shows the AIMB-275 motherboard with PPC-6191C-RMAE.

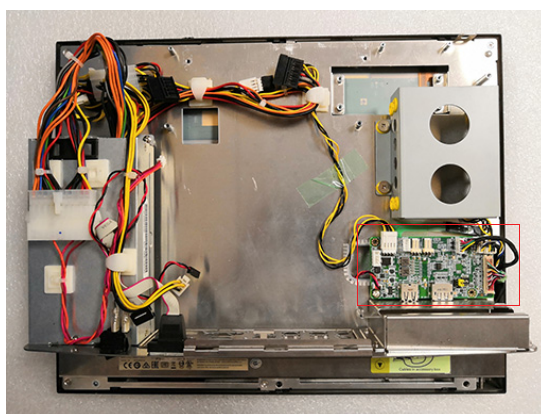
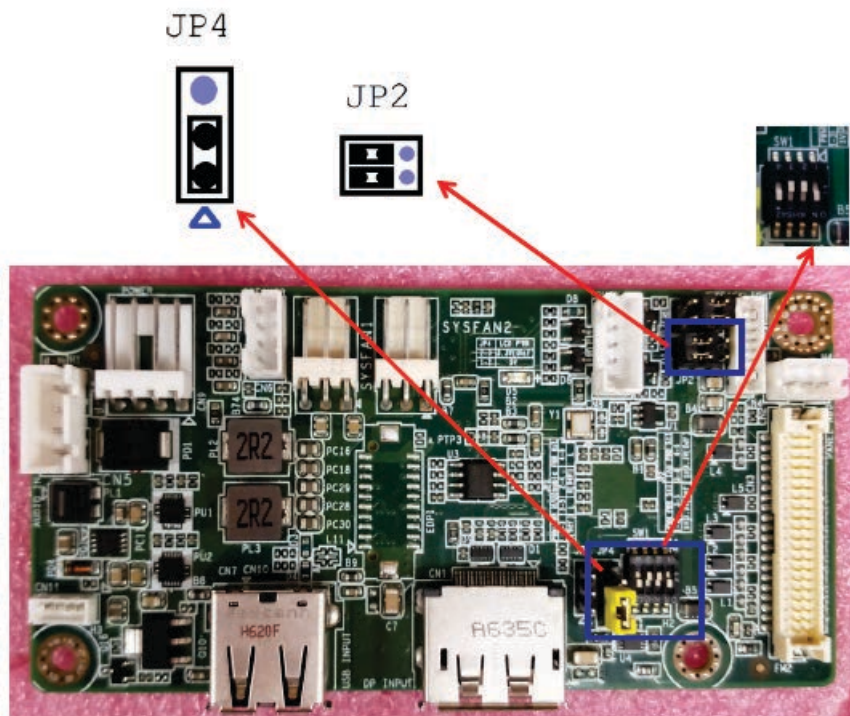

SW1	Resolution	1280 x 1024 (24 bit)
JP4	LED panel PWR	+5 V
JP2(4-6)	Backlight level	+3.3 V
JP2(3-5)	Brightness PWM level	+3.3 V

1. Retrieve the I/O bracket from the AIMB-275 accessory box.



2. Remove the I/O port blades.

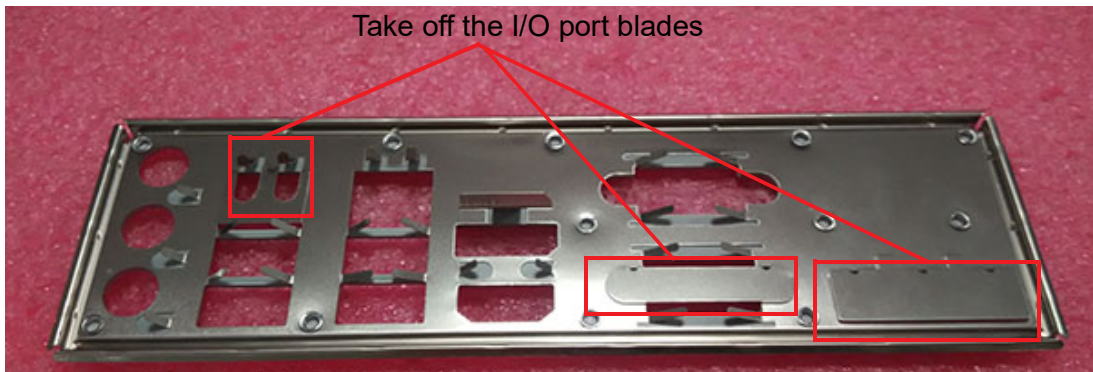

3. Install the motherboard I/O bracket into the chassis.

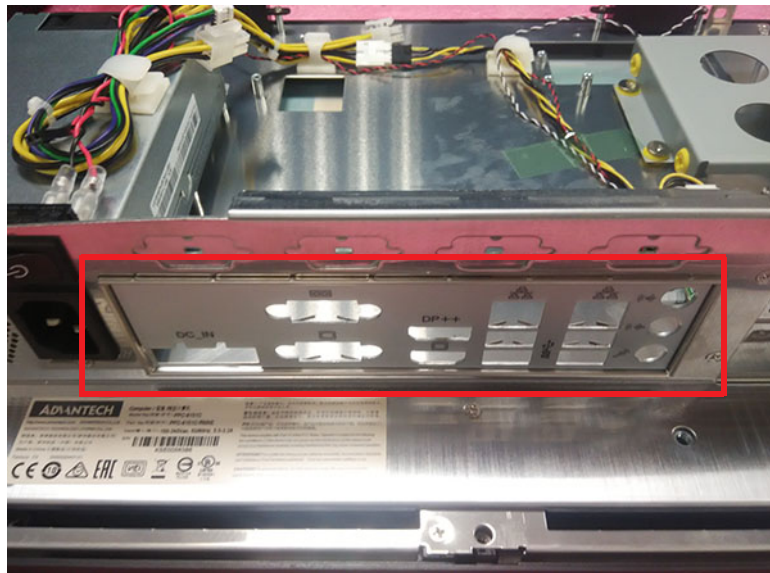

- Use four screws from the accessory box to affix the motherboard in place.

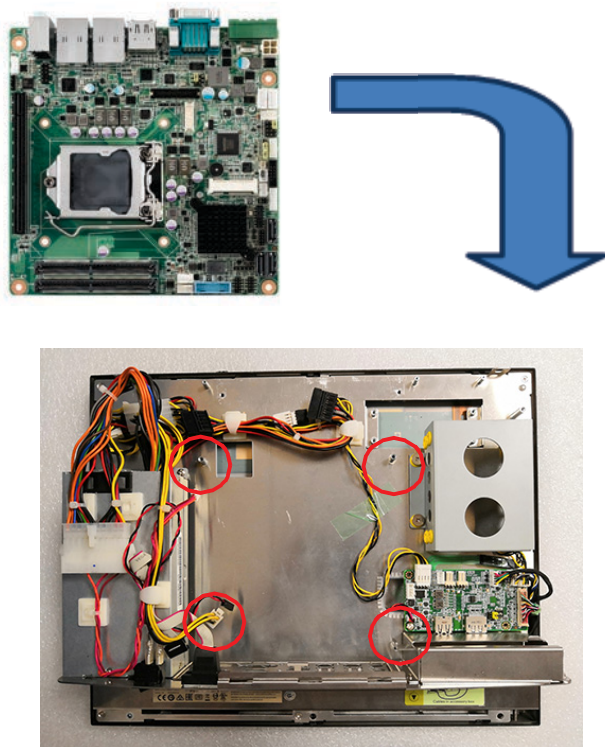

2.3.2 Connect the Motherboard Wires

PPC-6151C/6171C/6191C-RMAE and AIMB-275 assembly.

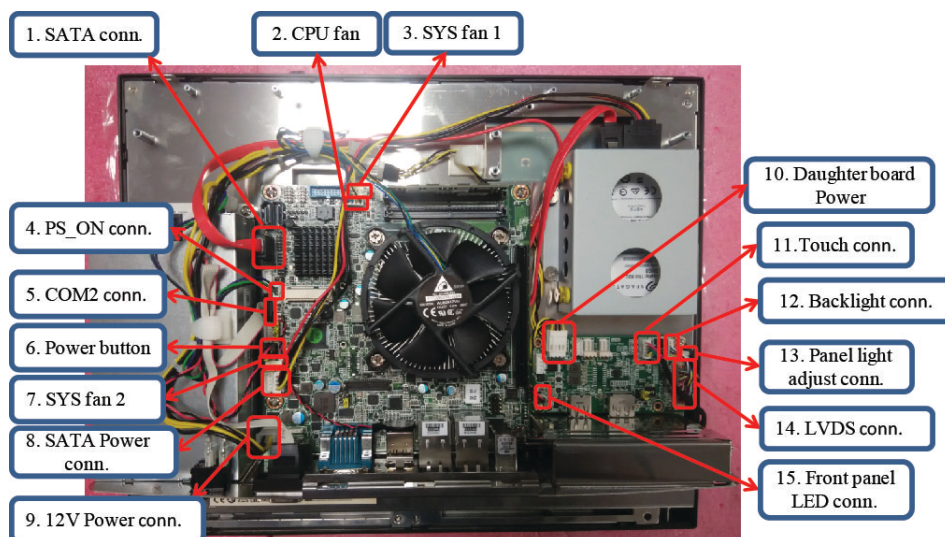

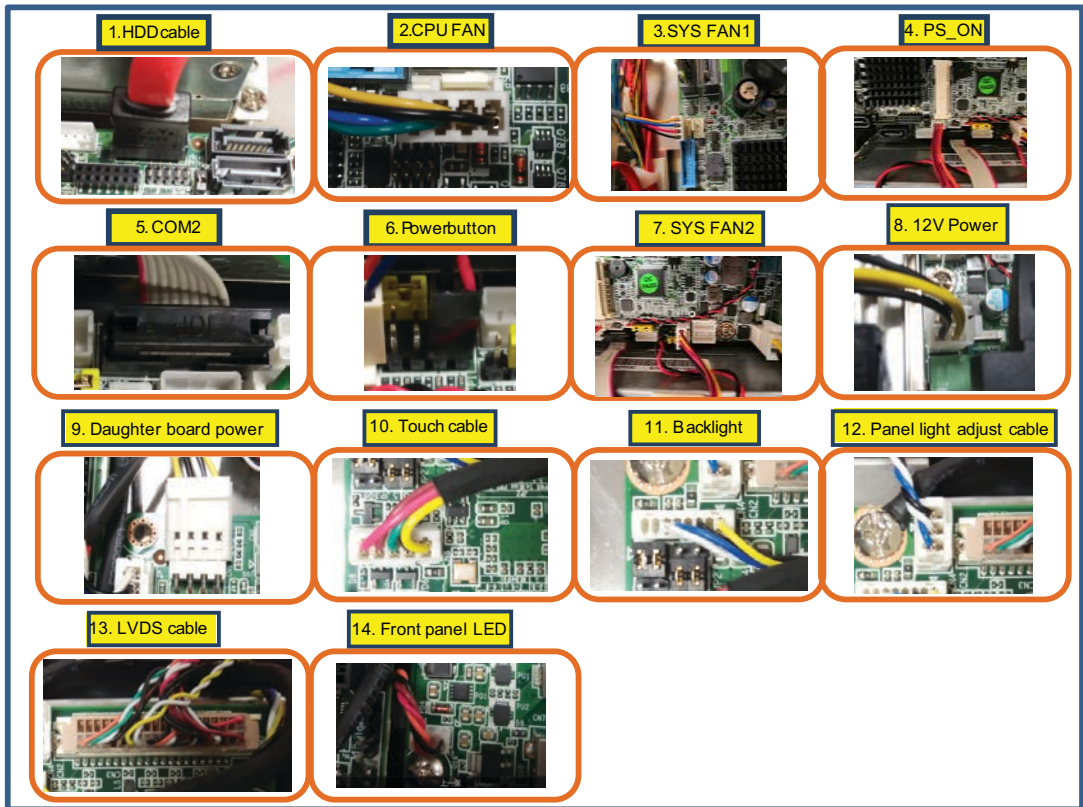

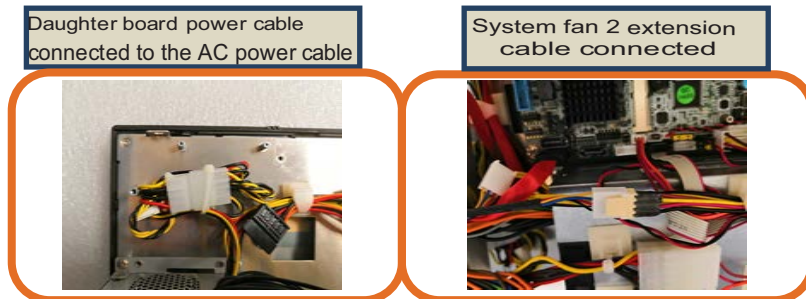

1. Connect the daughter board power cable and FAN2 cable.

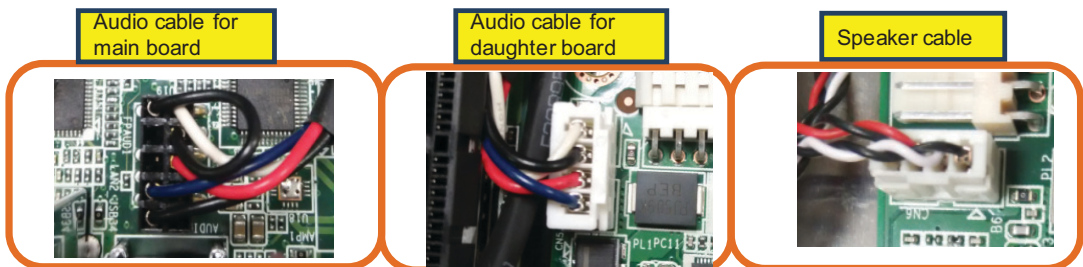

2. Connect the speaker cables as shown below.



- Note!**  Please refer to the PPC-6151C/6171C/6191C selection guide when selecting the motherboard type in order to ensure optimum performance, maximum security, and sufficient air circulation.
The cable connection is based on the motherboard specifications.

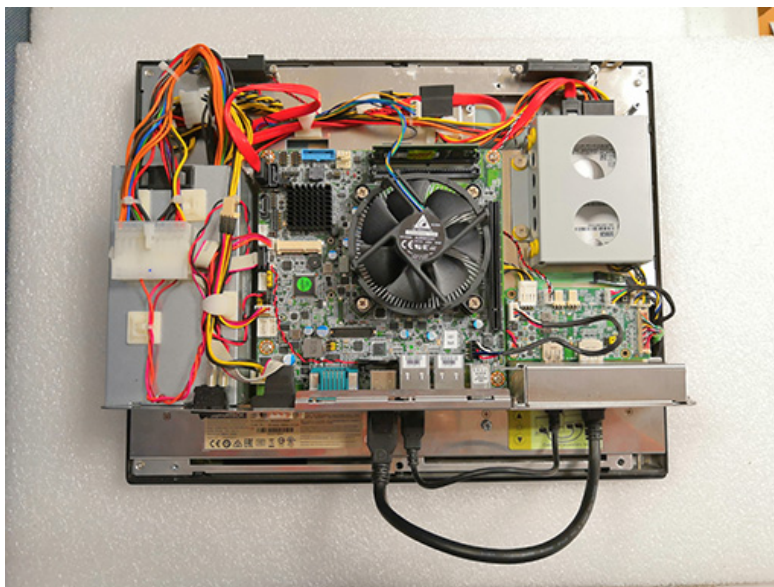

3. Retrieve DC bracket screws from the accessory box and affix the DC bracket in place.

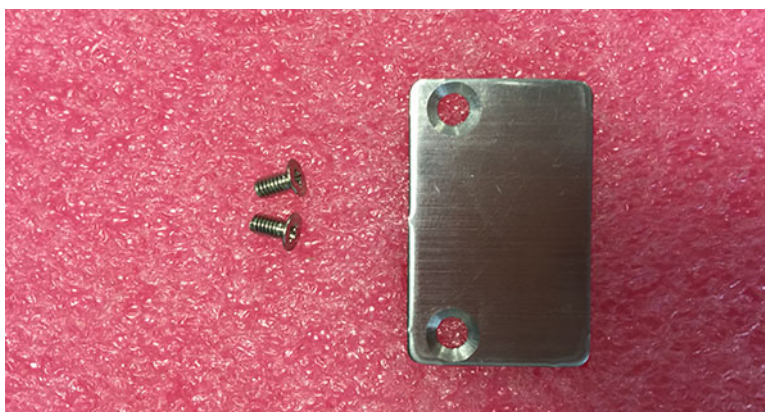

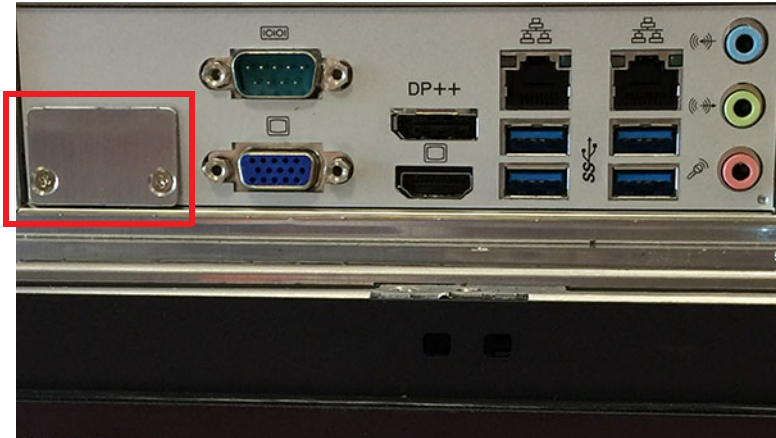

Note! For the PPC-6151C/6171C/6191C model, users are advised not use the DC port on the motherboard.



2.3.3 Connect the Daughter Board and Motherboard Using a Cable

1. Connect the DP input port with the motherboard DP port to enable the display. Connect the USB Input port with a motherboard USB port to enable touch function. (Cables are included in the accessory box.)

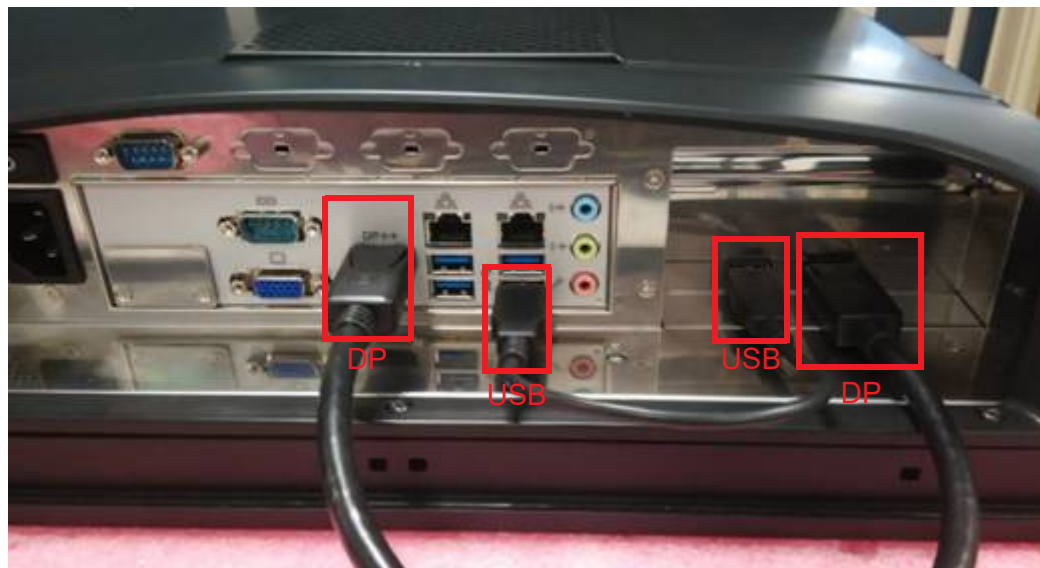

2. Connect the motherboard.

Note! Use a DP cable to connect the motherboard DP port and the chassis DP input port. Use a USB cable to connect one of the motherboard USB ports. The motherboards must have a DP port.



3. Connect the daughter board.



2.4 Component Setup

2.4.1 CPU Installation

Remove the CPU socket cover and install the CPU.

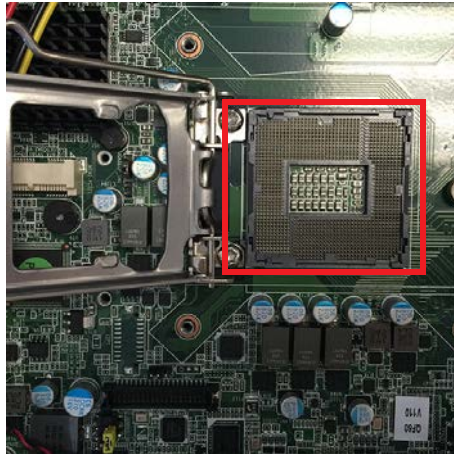

Note! Exercise caution when handling the motherboard CPU pins.
Refer to the datasheet when selecting the motherboard CPU.



Note! After CPU installation, ensure the CPU surface is covered in thermal grease. (Thermal grease is included in the PPC-MB-8260AE motherboard accessory box.)



2.4.2 CPU Cooler Installation

Using four screws, affix the cooler onto the motherboard. Then connect the cable to the motherboard. (Refer to the datasheet when selecting the CPU cooler. The cooler must be purchased separately.)

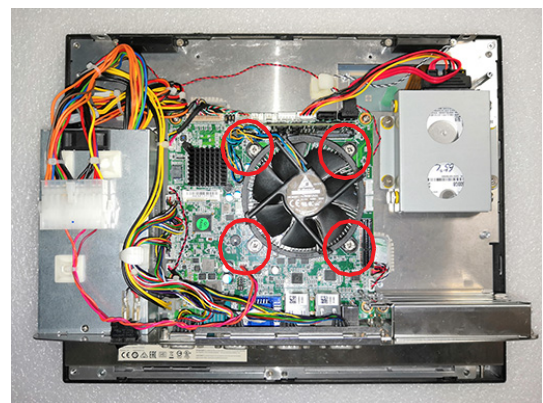

2.4.3 Memory Installation

1. Insert the memory card into the slot at a 45-degree angle. The gold fingers on the edge of the card must be completely inserted into the slot to ensure a secure connection.

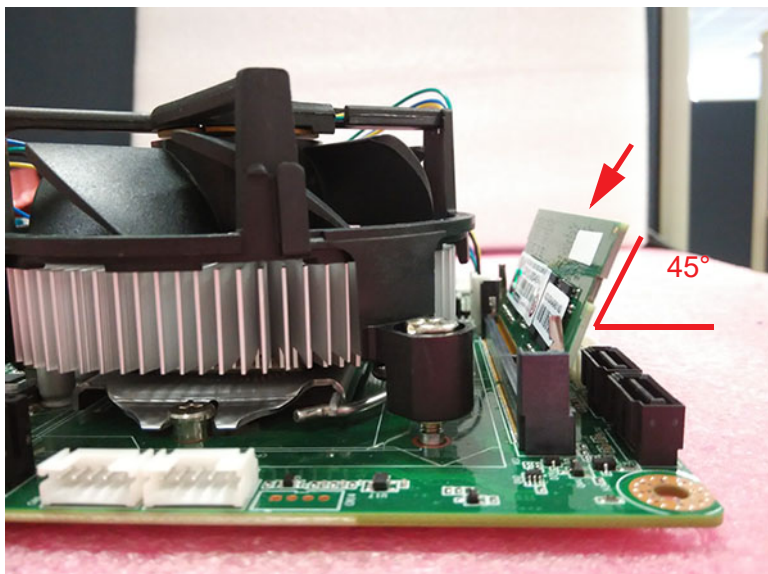

2. When the card is in the slot, apply firm pressure to the card until the clamps on the side click and lock the card into place.

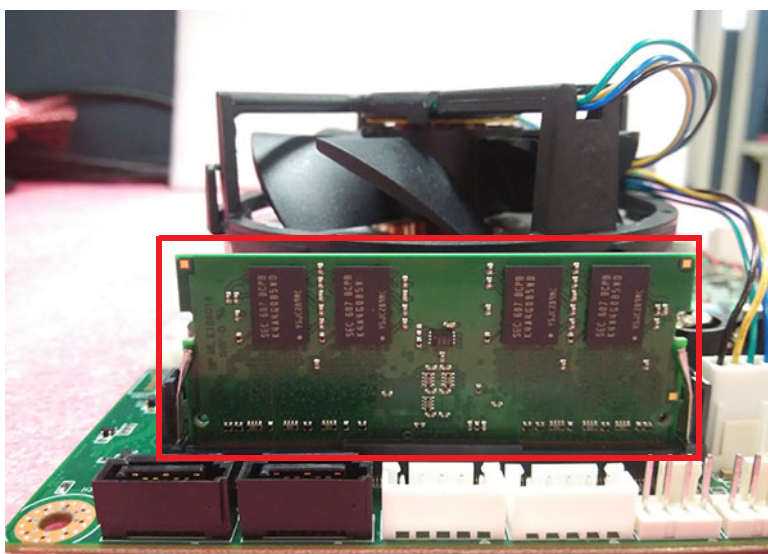

2.4.4 HDD Installation

2.4.4.1 Single HDD Installation

1. Unscrew the four screws indicated in the image below. Then remove the HDD bracket.

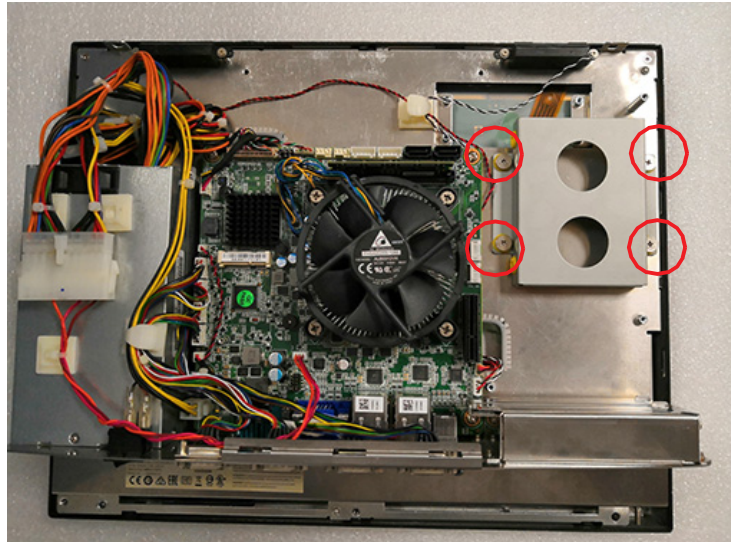

2. Place the HDD into the HDD bracket and affix it into place using four screws. (HDD screws are included in the accessory box.)



3. Reattach the HDD bracket and connect the SATA HDD cable. The assembled HDD module should appear as shown below.

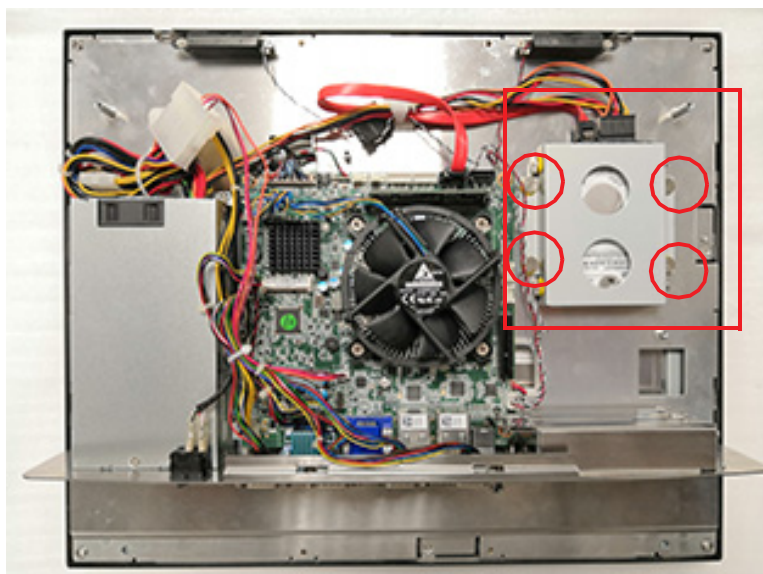

2.4.4.2 Double HDD Installation

Note! If using the double HDD kit, please order the P/N 98R36151C10.



Refer to the previous steps to open the machine.

1. Remove the Hard disk stent screws.

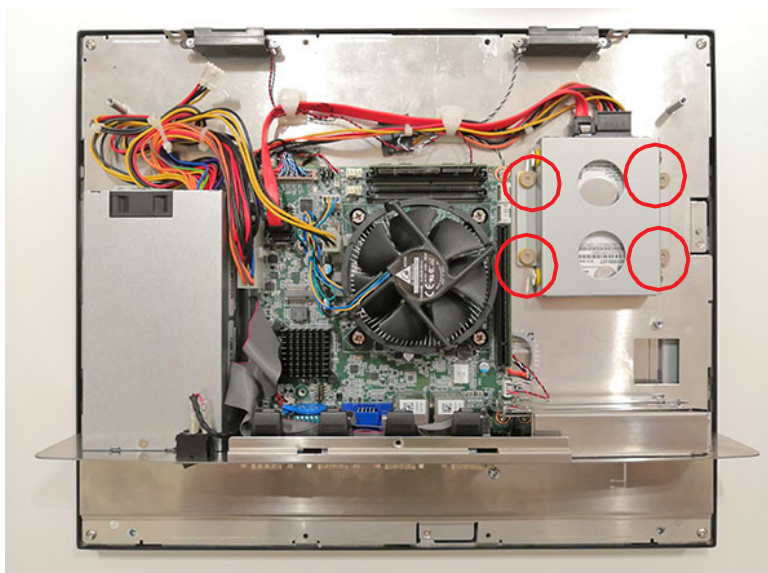

2. Take out the double HDD stent screws and lock the HDDs.



3. Lock the double HDD stent screws into the machine and connect the cable.

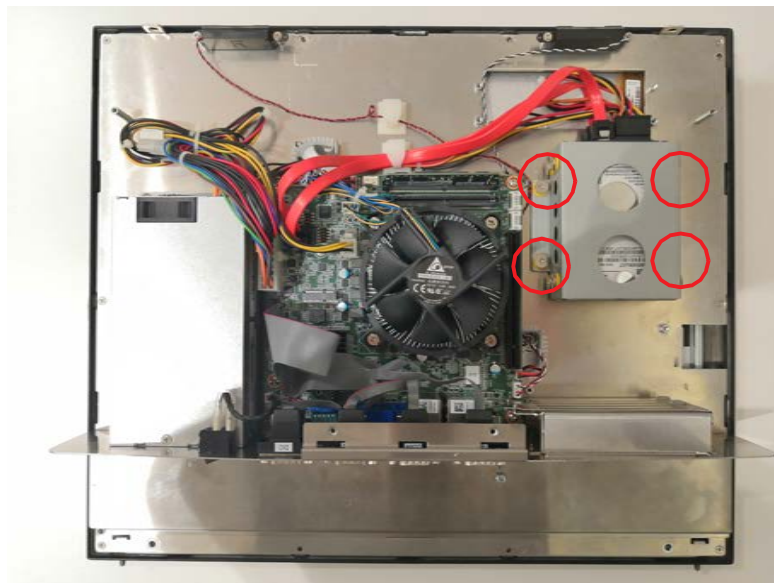

NOTE: The expansion slot below cannot be used.

2.4.5 Wi-Fi Module Installation

In the procedures listed below for installing a wireless LAN card, a PPC-WLAN-C1E motherboard is used in the example images.

1. Attach the wireless LAN card to the bracket using the screws provided with the Wi-Fi module.



2. Insert the wireless card into the appropriate mainboard slot. Then affix the card in place using a screw provided in the accessory box.



3. Connect the cables of the wireless LAN card to the antenna holder. Note the installation direction of the cable end and nut/washer.

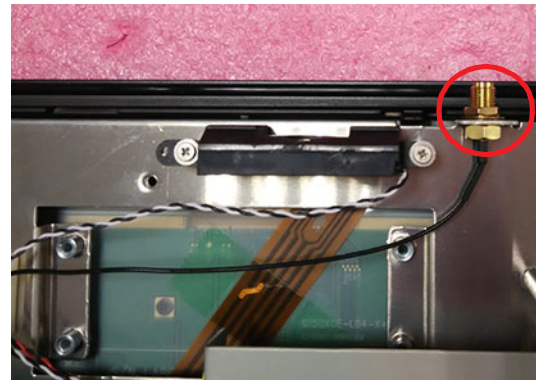
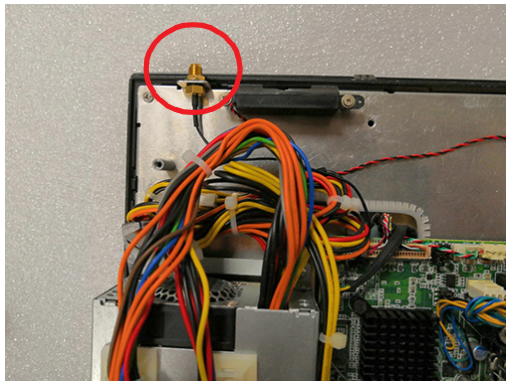

4. Lock the assembled antenna holder onto the machine. Then connect the cable to the wireless LAN card.

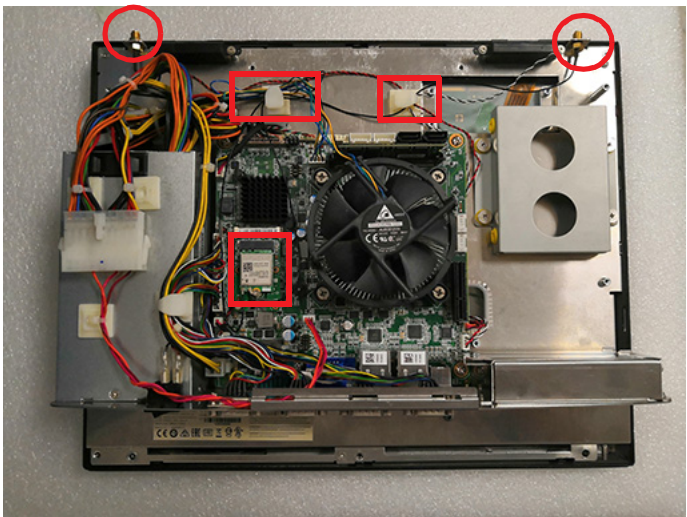

5. Install the bracket and then replace the rear cover (see Section 2.5.7).
6. Attach the wireless module antenna to complete installation.



2.4.6 Expansion Card Installation

1. Insert the PCI riser card (included in the PPC-6151C/6171C/6191C accessory box) into the slot and affix it in place using two screws. One PCIe x 4 and two PCI riser cards are provided in the PPC-6151C/6171C/6191C accessory box, allowing users to customize the system according to their requirements.

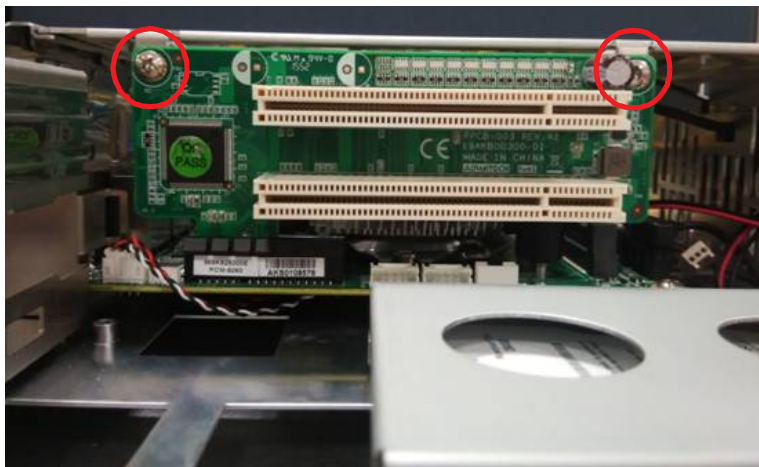

2. To change the PCI riser card to a PCIe x 4 riser card, first remove the PCI riser card. Then insert the PCIe x 4 riser card and affix it in place using two screws.

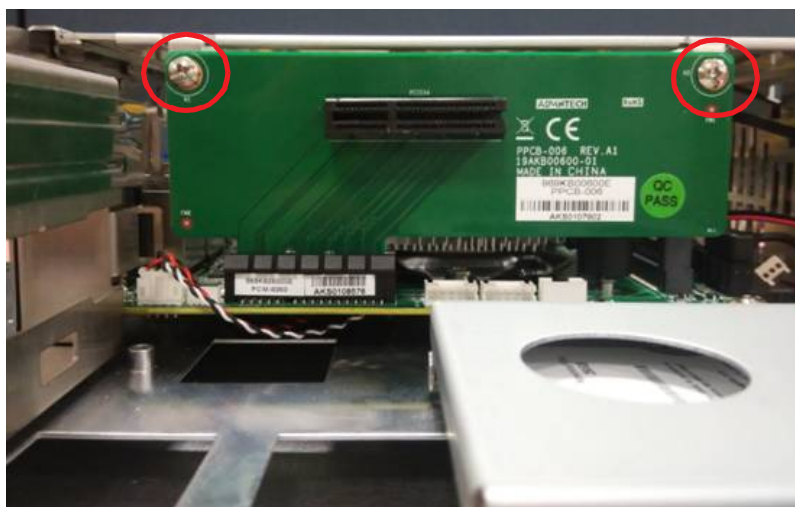

2.4.7 Graphic card Installation (Only for PPC-MB-610)

The following uses PPC-6171C-RTAE + PPC-MB-610 + SKY-QUAD-P2200-BLK for demonstration.

1. Unscrew the riser card screw to replace the riser card (9693BE20000)

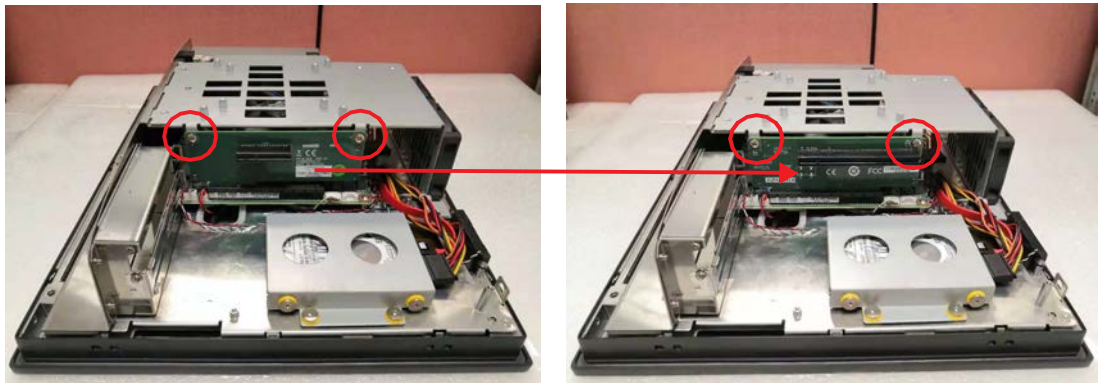

2. Install the graphic card into the PCIe slot and lock the screws

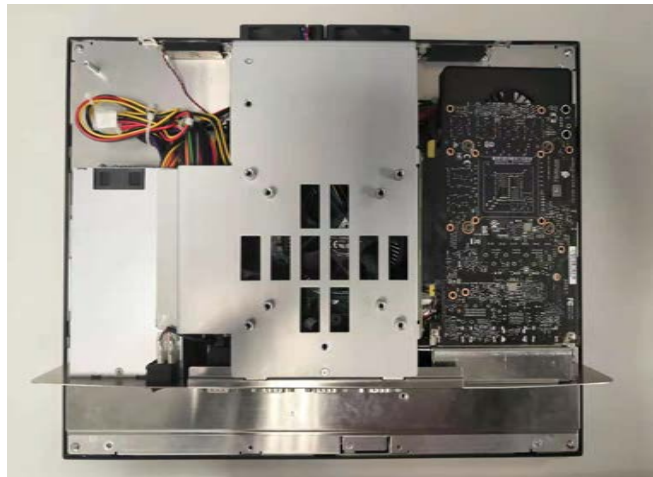

3. Install the support frame (only for PPC-6171C/6191C)

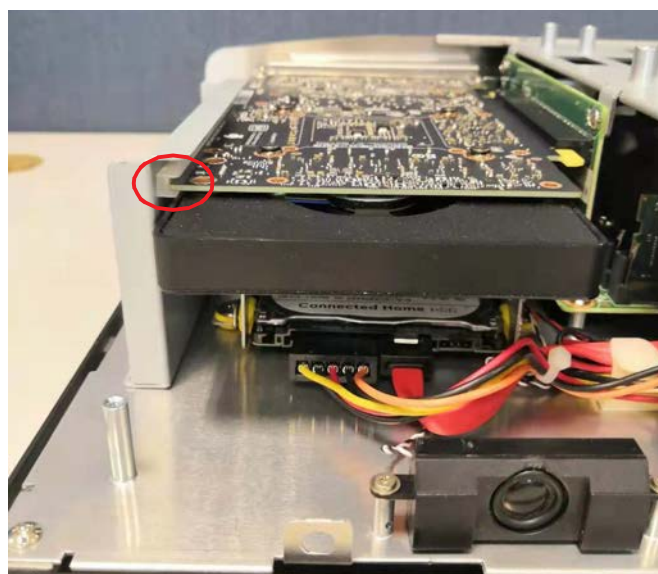

4. Attach the support frame with screws (only for PPC-6171C/6191C)

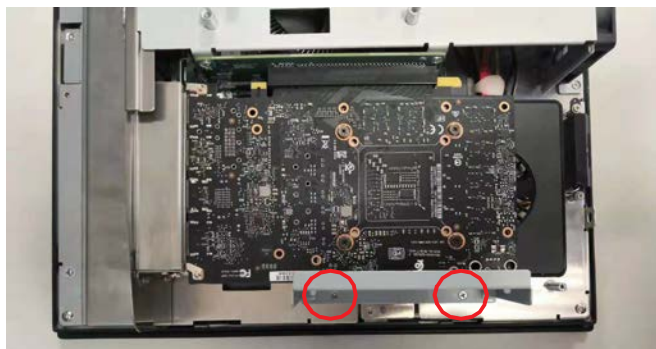

5. Reinstall the back cover to complete the installation

Note! For PPC-6000C, you need to change BIOS setting, otherwise only the external graphic card will be displayed, the integrated graphics card will not be displayed.



Power on and press the delete key to enter the BIOS setup. Under Graphics configuration, set the Primary Display to IGFX, press F4 save and exit.

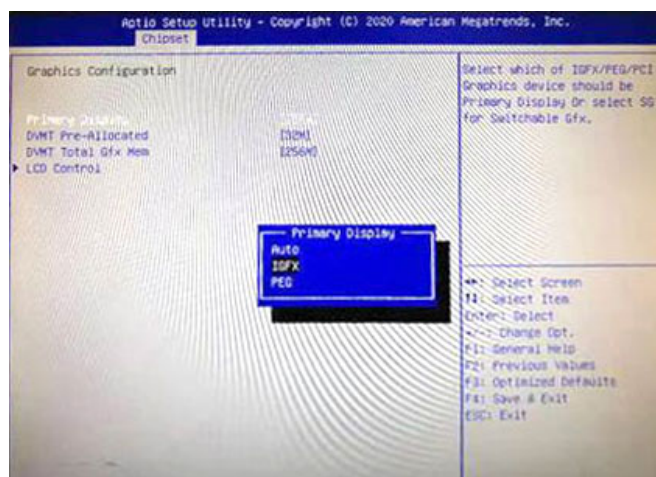

Also, set Multiple Displays as “Duplicate these displays” to get better performance.

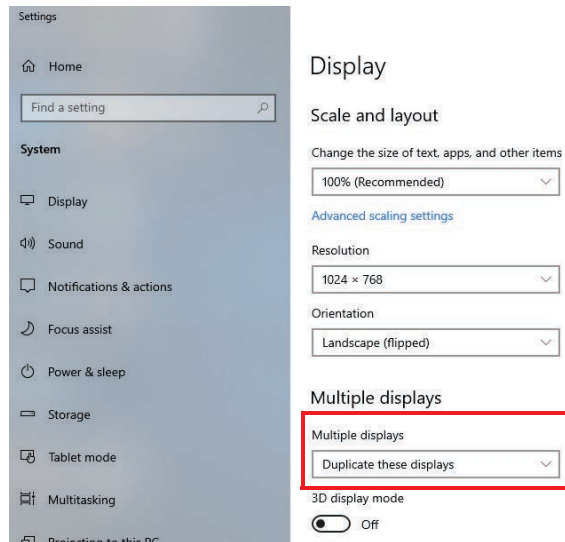

Note! The supported card sizes are as follows:



	Maximum card size (L*W*H)
PPC-6151C	178*107*20 mm
PPC-6171C	205*107*20 mm
PPC-6191C	205*107*20 mm

1. Recommend graphics card list as follows:

Graphic card PN	Description	TDP	Size	On PPC-6151C	On PPC-6171C	On PPC-6191C
GFX-NG710L16-3c	GT710 2G	14W	145x69x14mm	√	√	√
GFX-NG730L16-5C1	GT730 2G	32W	145x69x18mm	√	√	√
GFX-AE9171F16-5N	E9171 4G	40W	145x111x18mm	√	√	√
SKY-QUAD-P2200-BLK	Quadra P2200 5GB	75W	111x200mm	X	√	√

2.4.8 TPM Module Installation (only for PPC-MB-610)

1. Lock the TPM board.

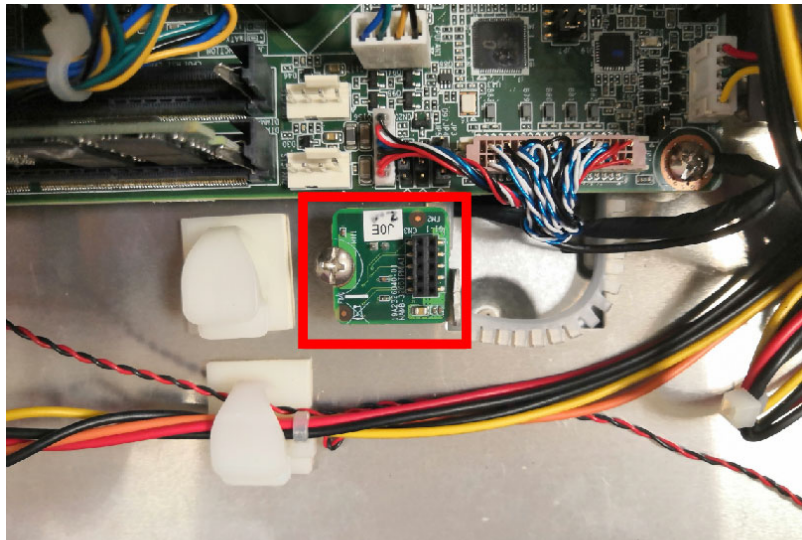

2. Connect the cable to TPM. (Notice the first pin)

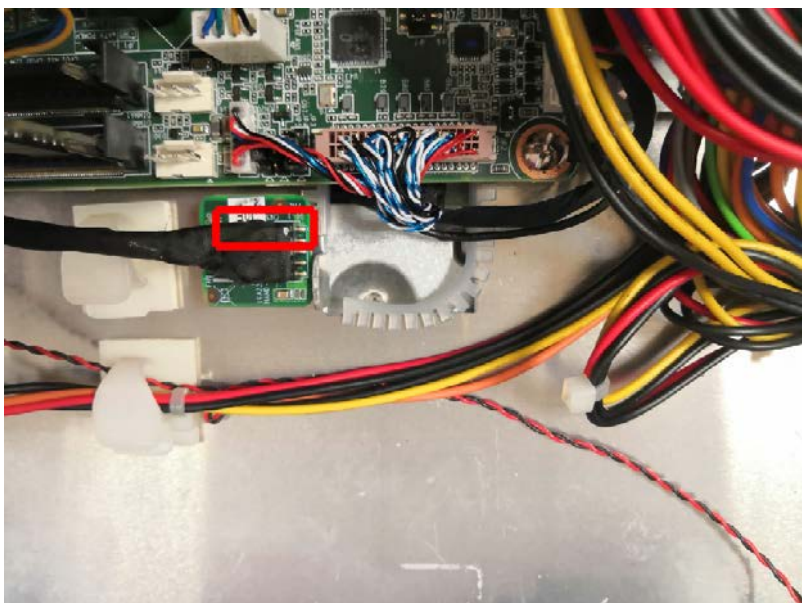

3. Connect the cable to TPM. (Notice the first pin)

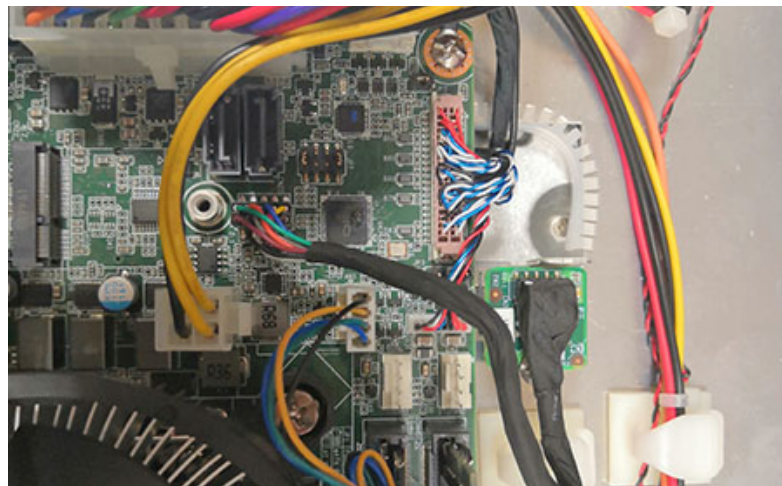
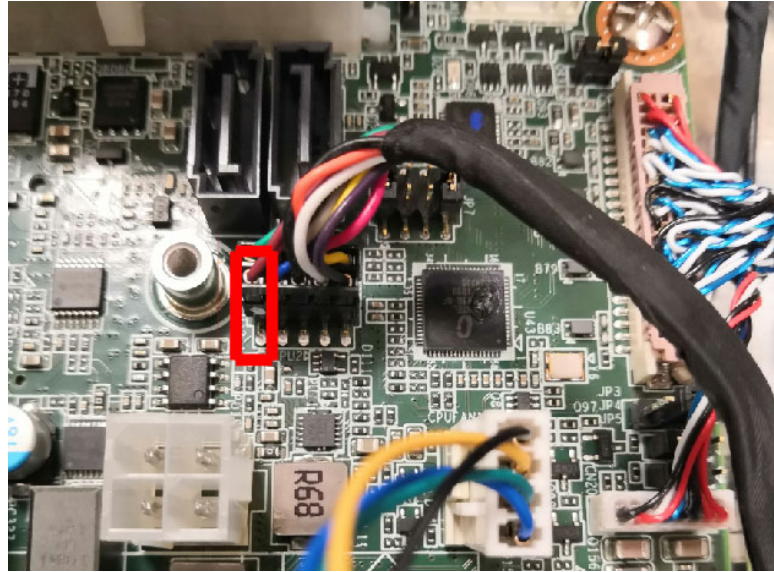

2.4.9 Rear Cover Installation

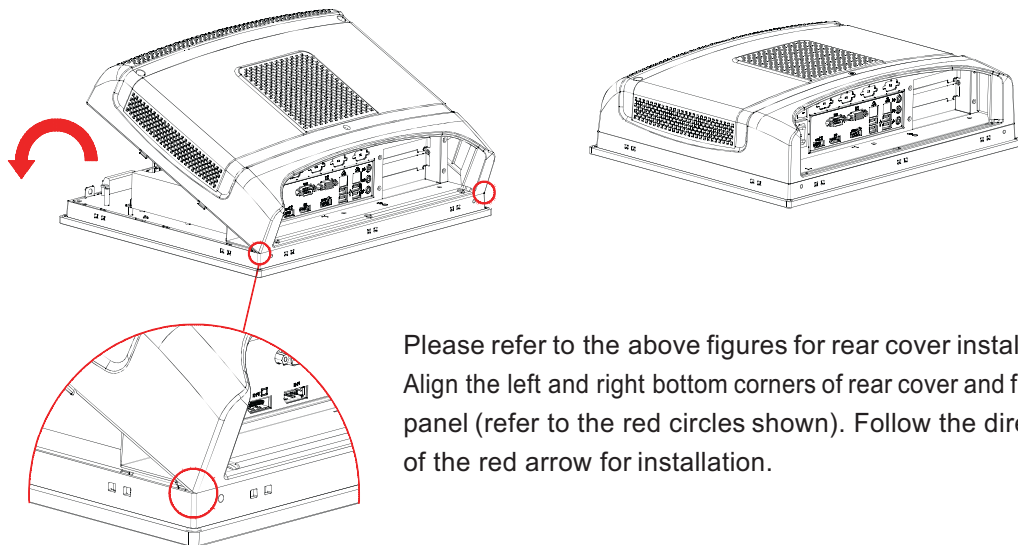

Please refer to the above figures for rear cover installation. Align the left and right bottom corners of rear cover and front panel (refer to the red circles shown). Follow the direction of the red arrow for installation.

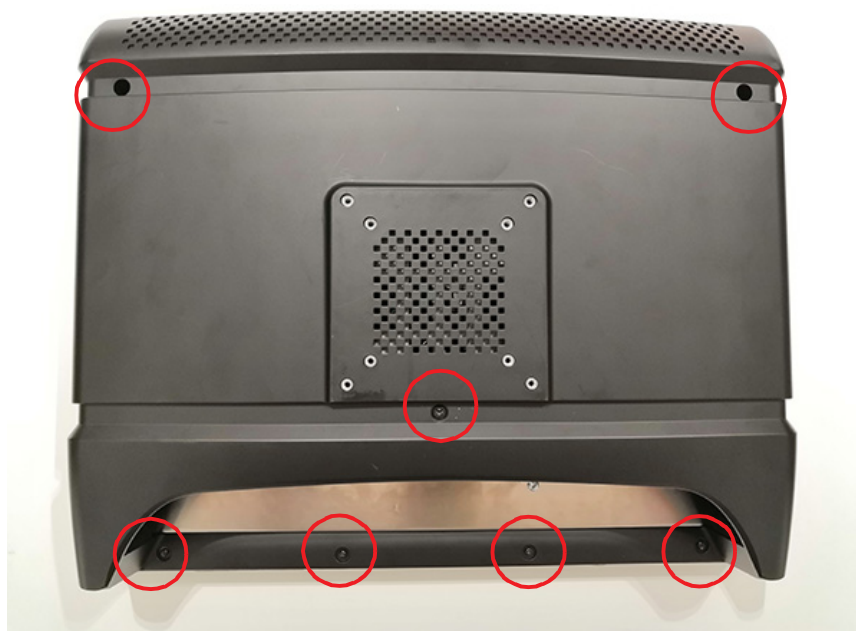

2.5 Mounting the System

Warning! When mounting the panel PC, more than one person should perform the installation to prevent accidental damage to the panel or personal injury.



Le comité constate qu'el-nasr "mounting, Plus d'une personne installation to prevent the cadre accidental damage to the personal injury.

The panel PC supports various mounting options, as listed below:

- Wall mounting
- Arm mounting
- Stand mounting
- Panel mounting

2.5.1 Wall Mounting

To mount the panel PC onto a wall, follow the instructions below.

1. Select the location on the wall for the wall mount plate.
2. Mark the locations of the two plate screws holes on the wall.
3. Drill two pilot holes at the marked locations on the wall.
4. Align the wall mount plate screw holes with the pilot holes.
5. Secure the mount plate to the wall by inserting screws into the two pilot holes and tightening them.

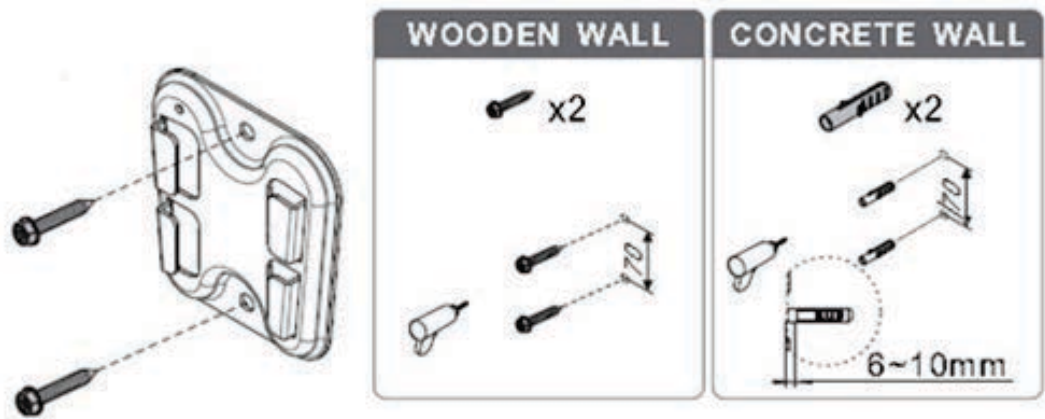

Figure 2.1 Wall Mount Plate

6. Insert four M4 screws into the holes on the panel PC and tighten them to secure the bracket to the rear panel.

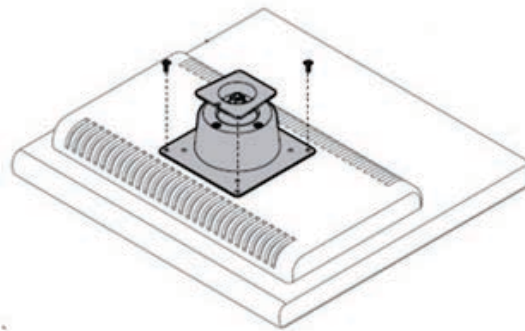
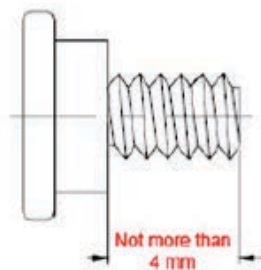

Figure 2.2 Screw Locations on the Rear Panel

Warning! Ensure that the thread depth of the screws on the rear panel does not exceed 4 mm (.15 in).



Assurez-vous que la profondeur du filetage des vis sur le panneau arrière ne dépasse pas 4 mm (.15 in).



7. To mount the panel PC on the wall, align the wall mount bracket attached to the panel PC with the wall mount plate on the wall and slide the panel PC downwards to hang the bracket on the mount plate.

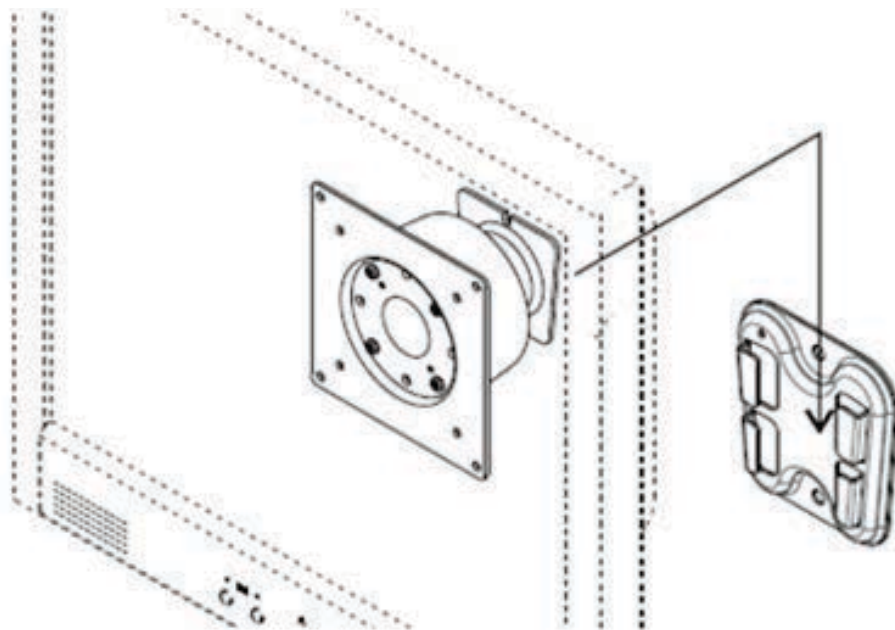

Figure 2.3 Mounting the Panel PC on a Wall

8. Secure the panel PC in place by tightening screws in the wall mount bracket.

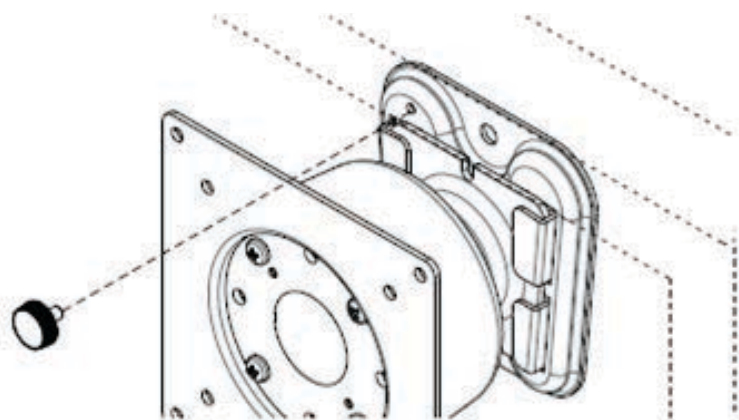

Figure 2.4 Securing the Panel PC

2.5.2 Arm Mounting

PPC-6151C / 6171C / 6191C can be mounted on a VESA-compliant arm mount with a 100 mm (3.93 in) interface pad. To affix the panel PC to an arm mount, follow the steps below.

1. Refer to the mounting arm installation instructions to correctly mount the arm onto the surface as a base.
2. Align the retention screw holes on the mounting arm interface with VESA holes in the panel PC, and secure the panel PC with the four M4 retention screws.



Figure 2.5 Arm Mounts for Panel PCs

Warning! *Ensure that the thread depth of the screws on the rear panel does not exceed 4 mm (0.15 in).*



Assurez-vous que la profondeur de filetage des vis sur le panneau arrière ne dépasse pas 4 mm.

2.5.3 Stand Mounting

Before stand mounting, check that the product was shipped with the following items:

Packing List							
No.	Name	Qty.	Pic.	No.	Name	Qty.	Pic.
A	Screw (M4x8L)	12 (4 x spare)		B	Screw (M4x6L)	6 (2 x spare)	
C	Screw (M4x5L)	2 (1 x spare)		1	Hinge	1	
2	VESA Bracket	1		3	Hinge Cover	1	
4	Base Plate	1					

To mount the panel PC onto the stand, follow the steps below:

1. Use four M4 x 8L screws to affix the VESA bracket to the panel PC. Users can choose between a 75 x 75 mm (2.95 x 2.95 in) or 100 x 100 mm (3.93 x 3.93 in) VESA mount according to their requirements.

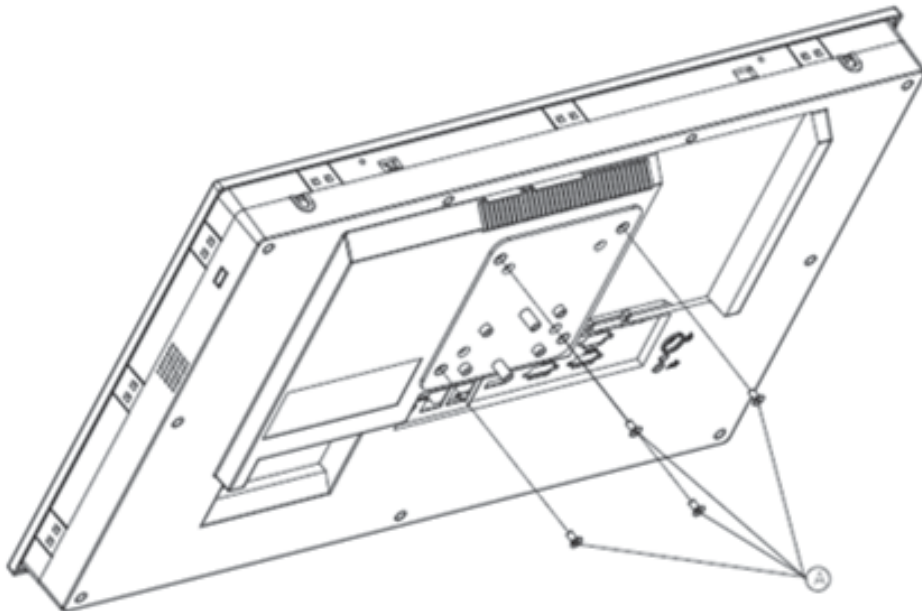

Figure 2.6 VESA Mount Screw Holes

2. Use the four M4 x 8L screws to secure the base plate to the mount stand.

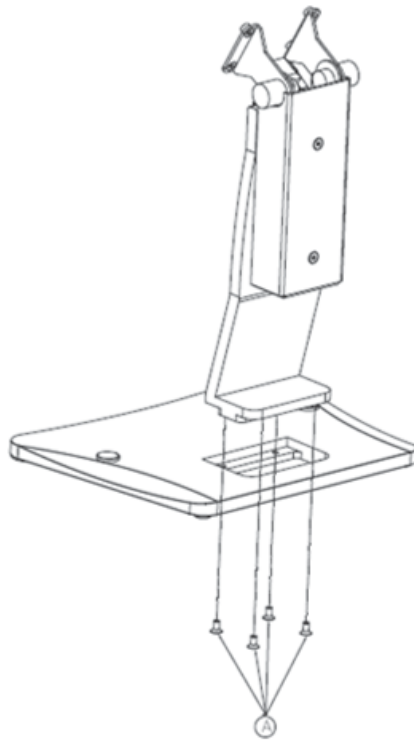

Figure 2.7 Securing the VESA Mount Base

3. Use four M4 x 6L screws to secure the mount stand to the VESA mount bracket.

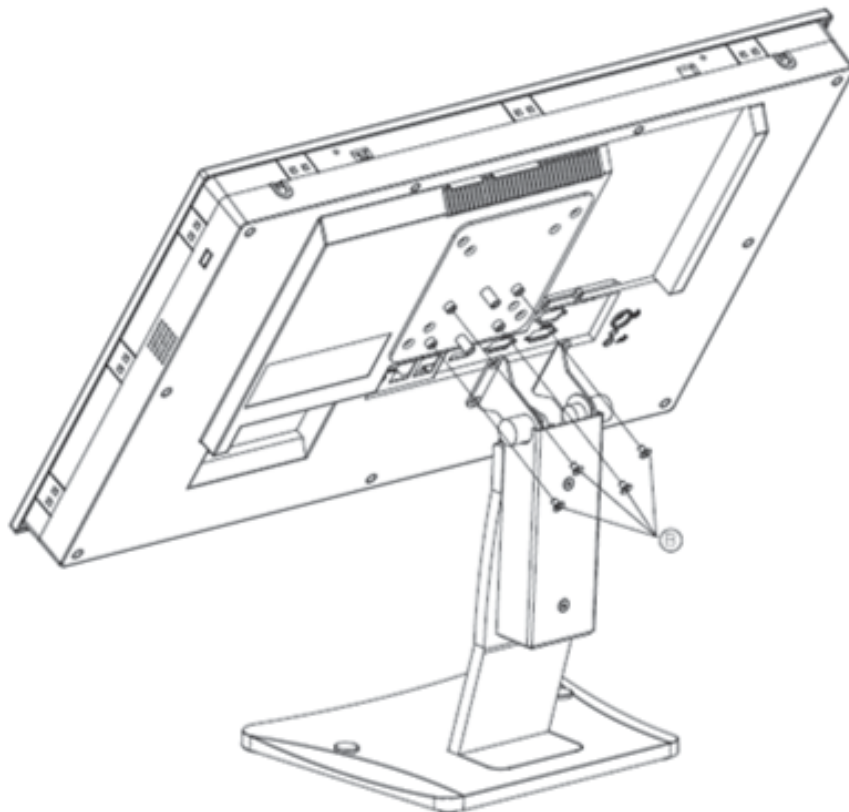

Figure 2.8 Securing the VESA Mount Bracket

4. Use one M4 x 5L screw to secure the stand mount hinge cover.

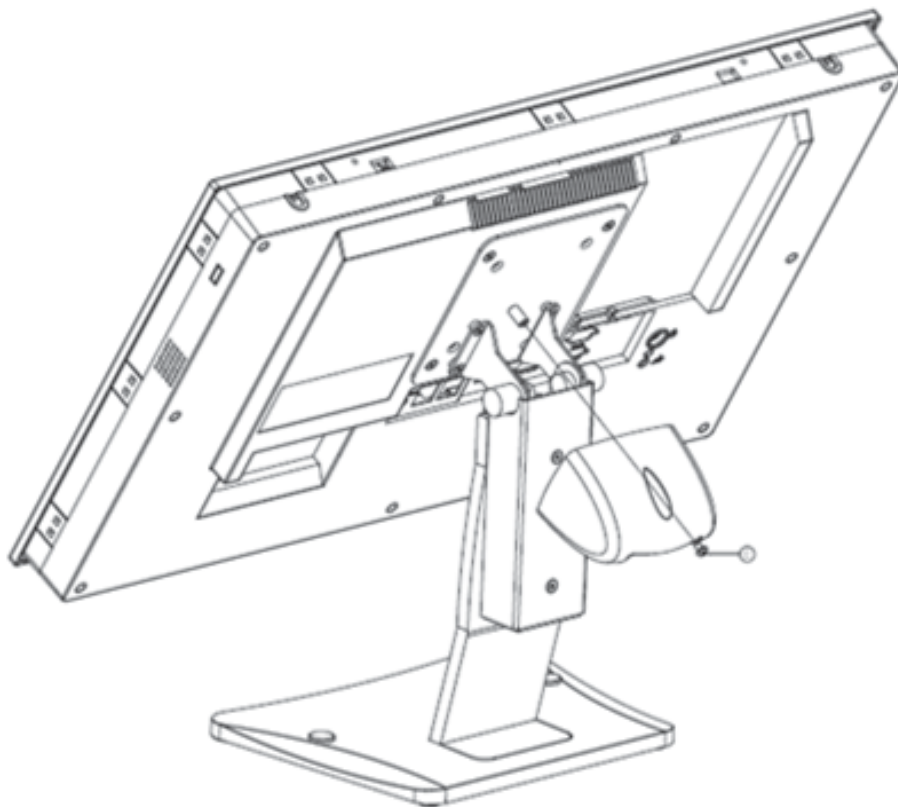

Figure 2.9 Securing the Stand Mount Hinge Cover

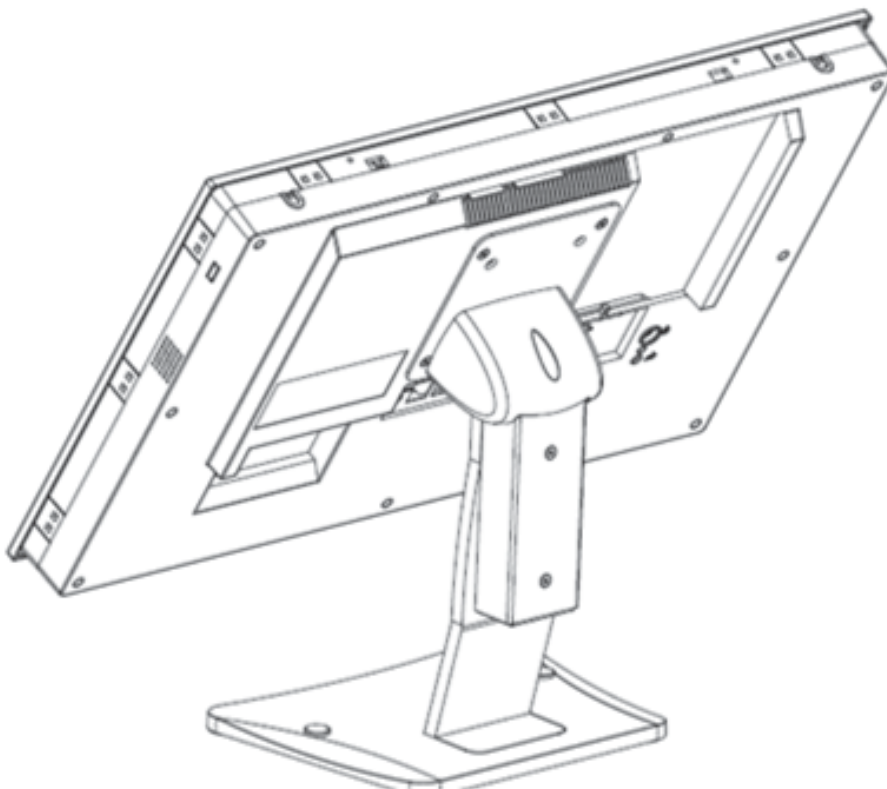
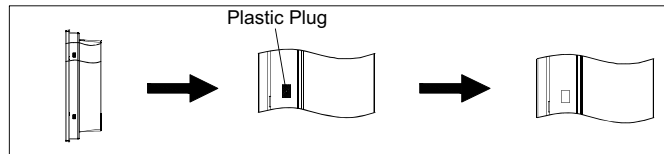

Figure 2.10 Completed Stand Mount

2.5.4 Panel Mounting

Panel Mount Bracket Installation



↓ Remove the plastic plugs around the machine using tweezers.

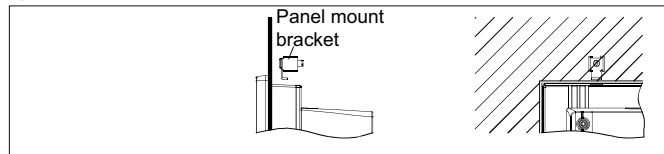

↓ Put the machine into the cabinet and get the wall mount brackets.

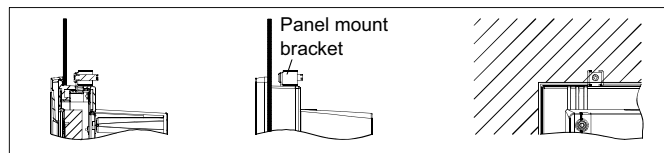

↓ Fix the machine in place by tightening the screws.

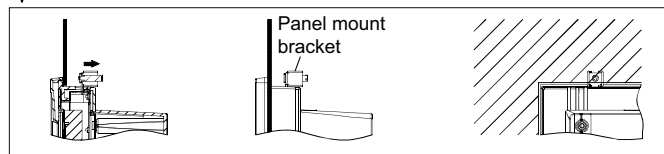

↓ Replace the plastic plugs according to the arrow and hookup machine.

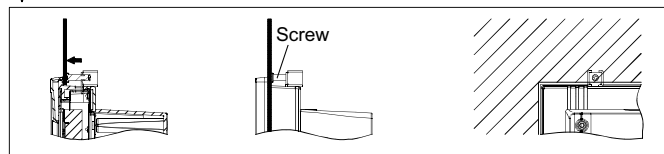

↓ Fix the machine in place by tightening the screws.

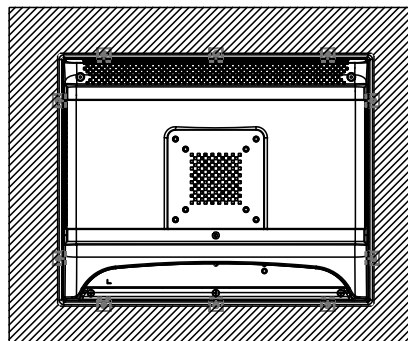

2.6 Quick Installation

Users can independently complete the panel wall mount installation by following the quick installation procedures listed below.

1. Loosen the two screws at the base (see the figure below).



2. Push the machine into a gap in the wall. The spring hook will lock the machine into the wall.



3. After mounting, the panel should appear as shown in the figure below. Then at the rear of the machine, lock the hook screw to fix the machine in place.

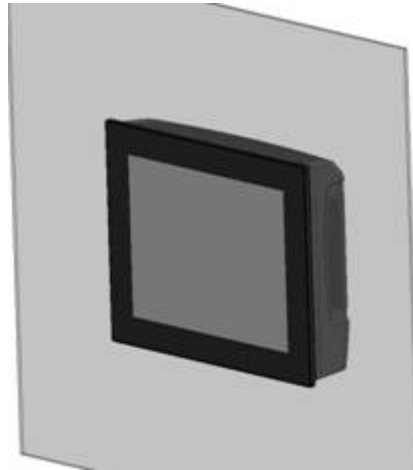

Note! According to the quick installation guide, the recommended mount thickness is no more than 2 mm (0.079 in). For other situations, the recommended thickness is 6 mm or less (0.236 in).



Appendix **A**

PCI/PCIE Riser Card

A.1 Riser Card Introduction

A.1.1 PPCB-003 PCI Riser Card

The total current load provided by the PPC-6151C/6171C/6191C PCI slot does not exceed 20 W. Additional details are provided below.

-12 V	0.1A
+12 V	0.5A
+5 V	4A
+3.3 V	2.5A
+3.3 VSB	0.25A

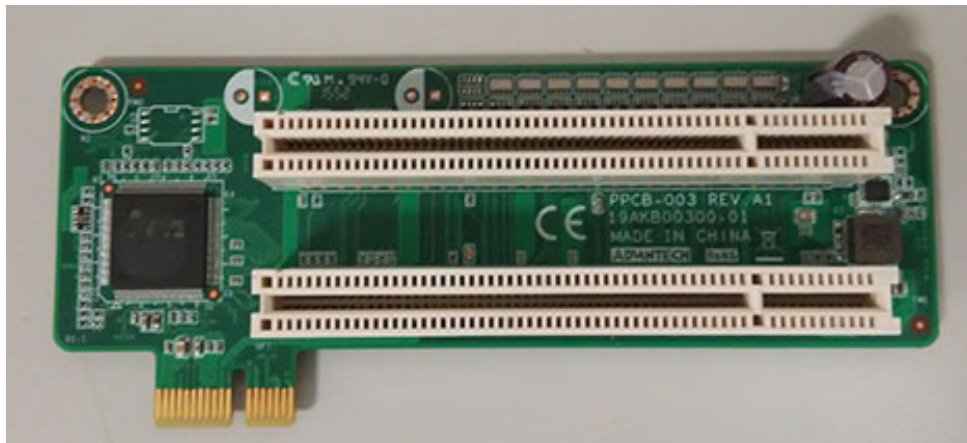

A.1.2 PPCB-006 PCIE x4 Riser Card

The total current load provided by the PPC-6151C/6171C/6191C PCI slot does not exceed 25 W. Additional details are provided below.

+12 V	2.1A
+3.3 V	3A
+3.3 VSB	0.375A



A.1.3 EAMB-BE02 2x PCIe x 1 Riser Card

The total current load provided by the PPC-6151C/6171C/6191C PCIe slot does not exceed 25 W. Additional details are provided below.

+12 V	2.1A
+3.3 V	3A
+3.3 VSB	0.375A



A.1.4 EAMB-BE03 1 x PCIe x 1+1 x PCI Riser Card

The total current load provided by the PPC-6151C/6171C/6191C PCIe and PCI slot does not exceed 25 W. Additional details are provided below.

-12 V	0.1A
+12 V	1.0A
+5 V	2A
+3.3 V	2.5A
+3.3 VSB	0.25A



A.1.5 EAMB-BE17 2 x PCIe x 8 Riser Card (for PPC-MB-610(U) only)

The total current load provided by the PPC-6151C/6171C/6191C PCIe slot does not exceed 25 W. Additional details are provided below.

+12 V	2.1A
+3.3 V	3A
+3.3 VSB	0.375A



A.1.6 EAMB-BE20 PCIe x 16 Riser Card (for PPC-MB-610(U) only)

The total current load provided by the PPC-6151C/6171C/6191C PCIe slot does not exceed 75 W. Additional details are provided below.

+12V	5.5A
+3.3V	3.0A
+3.3VSB	0.375A

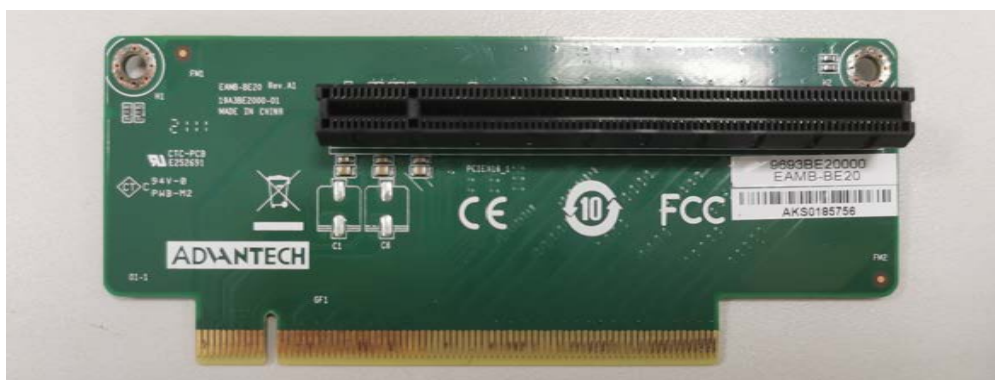

Note! The dimensions of the PCI and PCIe cards can not exceed 178 x 107 x 20 mm (for PPC-6151C), 205 x 107 x 20 mm (for PPC-6171C/6191C).



www.advantech.com

Please verify specifications before quoting. This guide is intended for reference purposes only.

All product specifications are subject to change without notice.

No part of this publication may be reproduced in any form or by any means, such as electronically, by photocopying, recording, or otherwise, without prior written permission from the publisher.

All brand and product names are trademarks or registered trademarks of their respective companies.

© Advantech Co., Ltd. 2021